



Benefitbee®

LOVE THE BEES, BENEFIT THE WORLD



2023.11
CATALOG



PRODUCT CATALOG

CHINA PROFESSIONAL BEEKEEPING SOLUTION PROVIDER

Shenzhen Benefitbee Bee Industry Co.,LTD
FengQingWanZhong Bee Industry Limited



Shenzhen Benefitbee Bee Industry Co.,Ltd

(FengQingWanZhong Bee Industry Limited)

深圳市益蜂蜂业有限公司, 成立于2009年, 是中国养蜂学会理事单位, 中国蜂机具专业委员会常务委员单位, 广东省养蜂学会副理事长单位, 中国畜牧业协会蜂业分会副会长单位, 深圳潮汕商会常务理事单位, 深圳网贸会副会长单位。

Established in 2009, Shenzhen Benefitbee Bee Industry Co., LTD (FengQingWanZhong Bee Industry Limited) is standing corporate member of China Beekeeping Equipment Committee, council member of Guangdong Apiculture Association, Vice President Unit of CAAA(China Animal Agriculture Association) Apiculture Branch, Council Unit of Shenzhen Chaoshan Commerce Chamber, Vice President Unit of Shenzhen E-commerce Association.

目前经营1100多种养蜂机具, 拥有40多项发明、实用新型和外观等专利, 每年上百种养蜂机具新品研发, 年出口额名列行业前茅, 旗下Benefitbee品牌系列蜂机具在国际上有很高的知名度, 公司常年为国内外同行设计、研发、生产、供应各种新型养蜂机具。

We are managing more than 1100 types of beekeeping equipment. Practical and appearance patents, our equipment with Benefitbee brand are enjoying highly reputation in international market. Throughout years, we design, develop, produce and supply new style equipment for peer company home and abroad.



是一家集设计、开发、生产与出口销售各种养蜂装备的一站式专业制造商, As a professional manufacturer Integrating designing, development, production and sales.



DESIGNING



DEVELOPMENT



PRODUCTION



SALES



With more than 40 inventions

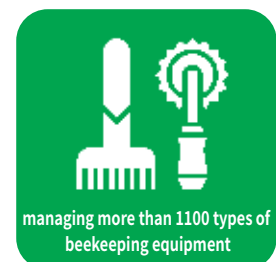

managing more than 1100 types of beekeeping equipment



Subsidiary factory

旗下五金塑料工厂——阳江市益蜂蜂机具有限公司，坐落于有“世界刀城”之称的工业重地——广东省阳江市，拥有中国发达的工业制造技术与产业配套优势，目前拥有一整套完善的模具开发与生产设备，年产各种养蜂刀具200多万把，金属隔王板50多万片，喷烟器20多万个，塑料巢础200多万片，塑料隔王板100多万片，塑料巢框50多万个，拥有塑料和五金蜂机具模具400余副。

Affiliated to Benefitbee, Yangjiang Benefitbee Beekeeping Equipment Co., LTD is located in an important knife production base Yangjiang, which is called “World’s Knife City”. With China advanced manufacturing technology and supporting advantages, Yangjiang Benefitbee’s annual production capacity reaches:

>2,000,000 hive tools

>2,000,000 plastic foundations

>500,000 metal queen excluders

>1,000,000 plastic queen excluders

>200,000 bee smokers

>500,000 plastic frames

Until now, we have produced more than 400 sets of plastic and hardware tooling.

旗下蜂箱工厂——黄山市益蜂蜂箱有限公司，位于美丽的安徽省黄山市，拥有优势的木材原材料资源以及先进的生产设备，工厂占地20亩，年产蜂箱10万套，巢框200万个，木制隔王板50多万片，进出口资质齐全，常年为澳大利亚、新西兰、美国、韩国等国家生产和出口高质量的蜂箱产品。

Shenzhen Benefitbee, Huangshan Benefitbee Beehive Co., LTD is located in a pretty city called Huangshan, in Anhui Province, owning advantageous raw material sources and advanced production equipment. Huangshan Benefitbee occupies an area of 1.5 hectares, annually produces 100,000 beehives, 2 million frames, more than 500,000 wooden queen excluders. Anhui Benefitbee is a qualified exporter supplying high quality beehives to Australia, New Zealand, USA and Korea.

公司自创立以来，充分发扬自主创新的精神，凭借多年来的蜂机具出口与制造经验、珠三角得天独厚的交通便利，秉着“关爱蜜蜂、造福人类”的企业使命，“巧夺天工，精益求精”的质量方针，“一言九鼎、无微不至”的经营理念，不断提升在品种、质量、价格以及服务上的综合竞争优势，赢得世界众多知名企业的认可并且建立了战略合作伙伴关系，产品远销全球140多个养蜂强国及地区。

Since establishment, Benefitbee has been carrying strong spirit of self innovation, relying on extensive experiences and unique transportation networks, we are making continuous progress in becoming more competitive in product range/quality/price/Service. Holding the mission of “Love the bees, Benefit the world”, with the philosophy of “Keeping a solemn promise, granting the best care”, we have won the recognition from many famous beekeeping enterprises and established strategic partnership with them. Benefitbee products have been sold to more than 140 countries and areas with powerful apiculture.

企业的成功来源于高品质的产品、优质的服务以及客户的信赖。我们真诚期望与世界蜂业界朋友们建立友好长久的合作关系，为中国乃至世界养蜂业的快速发展而携手并进！

Business success results from high quality product, excellent service and customers’ trust. We sincerely expect to build long term partnership with friends from apiculture industry. Let’s work shoulder to shoulder, hand in hand, to make contribution to rapid development of world’s apiculture!





We are different



D1 Variety

Shenzhen Benefitbee Bee Industry Co., Ltd(FengQingWanZhong Bee Industry Limited) operates more than 800 beekeeping tools currently, 40% of which are self-produced. We invest hundreds of thousands of dollars for mold; research & develop dozens of new products every year. We are the veritable one-stop beekeeping equipment supplier in China. The non-stop innovation ability determines our competitive advantage in the industry, but we believe that our advantage is not only the 800 products, but also the solution provide capacity of demand plan for the beekeeping tools and machine.



D2 Quality

We refuse to exchange low quality for low price. The quality stability and functional practicability of our products are the necessary standards for measuring our products. The continuous upgrading and improvement of our products is the direction of our work. With more than ten years of experience in research & development, production and sales of beekeeping tools, we strictly control the products quality for our customers. Not all beekeeping tools can enter our catalogue. We promise that the products will be refunded in full if they have quality problems.



D3 Price

40% of the varieties are self-produced and sold, first-hand sources. Although 60% are outsourced products, but our huge annual purchase volume determines our position, delivery, price, and quality standards with partners. The same quality with lower price, the same price with higher quality is our commitment to customers. Under the same conditions and the same price, if you find that the price is higher, we promise to refund the price difference.



D4 Service

The prosperous Shenzhen Special Economic Zone will inevitably have high labor costs, but it provides us with a high-quality service team. 100% customer satisfaction is our pursuit, you will get our convenient, time-saving, money-saving and reassuring service during pre-sale, in-sale and after-sales! Your appeal is the source of our growth! If you have any service issues, welcome to direct complaint to the general manager's email: elvis@benefitbee.com



D5 Transportation

Shenzhen Benefitbee Bee Industry Co., Ltd(FengQingWanZhong Bee Industry Limited) is headquartered in the Shenzhen Special Economic Zone, adjacent to Yantian Port, which is the largest port in China, also near to ports such as Shekou, Nansha and Huangpu. We can provide you with fast, convenient and cost-effective transportation solutions.



D6 Industry

Our factory is located in the industrial city of China's Pearl River Delta. It has China's advanced production technology and industrial supporting advantages, such as the world's knife city in Yangjiang and the plastic mold capital in Dongguan. Its top industrial level creates first-class product quality.



D7 Experience

Since its establishment in 2009, our products have been exported to more than 130 countries and regions, and we have visited dozens of countries and regions in the field. We have deep knowledge of beekeeping habits, market demand and product standards in most countries and regions around the world. These valuable experiences have created our comprehensive service capabilities!



D8 Scale

Our company currently has 2000 square meters of hardware products factory; 1,500 square meters of plastic products factory; 3000 square meters warehouse distribution center; goods value of nearly 1 million US dollars in stock; 1000 square meters office; 400 square meters comprehensive exhibition hall; total employees more than 120 people; more than 300 carefully selected suppliers with high quality supporting. We strive to build our comprehensive strength to protect your logistics supply.



D9 Background

Shenzhen Benefitbee Bee Industry Co., Ltd (FengQingWanZhong Bee Industry Limited) is the governing unit of Chinese Beekeeping Society; the standing corporate member of the Chinese Beekeeping Equipment Committee and the Council Member of Guangdong Apiculture Association. We have never stopped communicating and learning with industry experts and scholars, which provides a valuable source for our research & development capacity!



Catalog



Catalog

01-12	Beehives	
13-14	beehive parts	
15-17	Hive accessories	
18-21	Frames	
22	Comb foundation	
23-24	Economy wire tools	
25	Bundle tools	
26-30	Queen excluders	
31	Pollen traps	
32-34	Bee feeders	
35-43	Bee smokers	
44-47	Honey extractors	
48-51	Hive tools	
52-54	Uncapping knives	
55-56	Uncapping forks	
57-58	Frame grip tools	
59-61	Filter tools	
62-63	Cleaning tools	
64-65	Bee brush	
66-67	Bee gloves	
68-70	Bee suits	
71	Bee hats	
72-74	Queen cages	
75-77	Queen breed tools	
78-79	Other products	
80-81	Pest control tools	
82-83	Bee medicines	
84	Bee wax	
85	Bee fodder	
86-88	Honey tank	
89	Honey pail	
90	Honey gates	
91	Wax press	
92	Beeswax foundation roller	
93-94	Honey processing machines	
95-97	Candle silicone moulds	
98	Beeswax silicone moulds	
99	Beeswax candle	
100	Resin crafts	
101	Honey bottle	
102-103	Bee crafts	
104	Bee broochs	
105	Bee accessories	
106	Bee 3D pictures	



Beehives

Benefitbee®

BB Plastic beehive

This 1-floor multifunctional plastic hive consists of top cover, top feeder, inner cover, deep box, excluder and bottom.

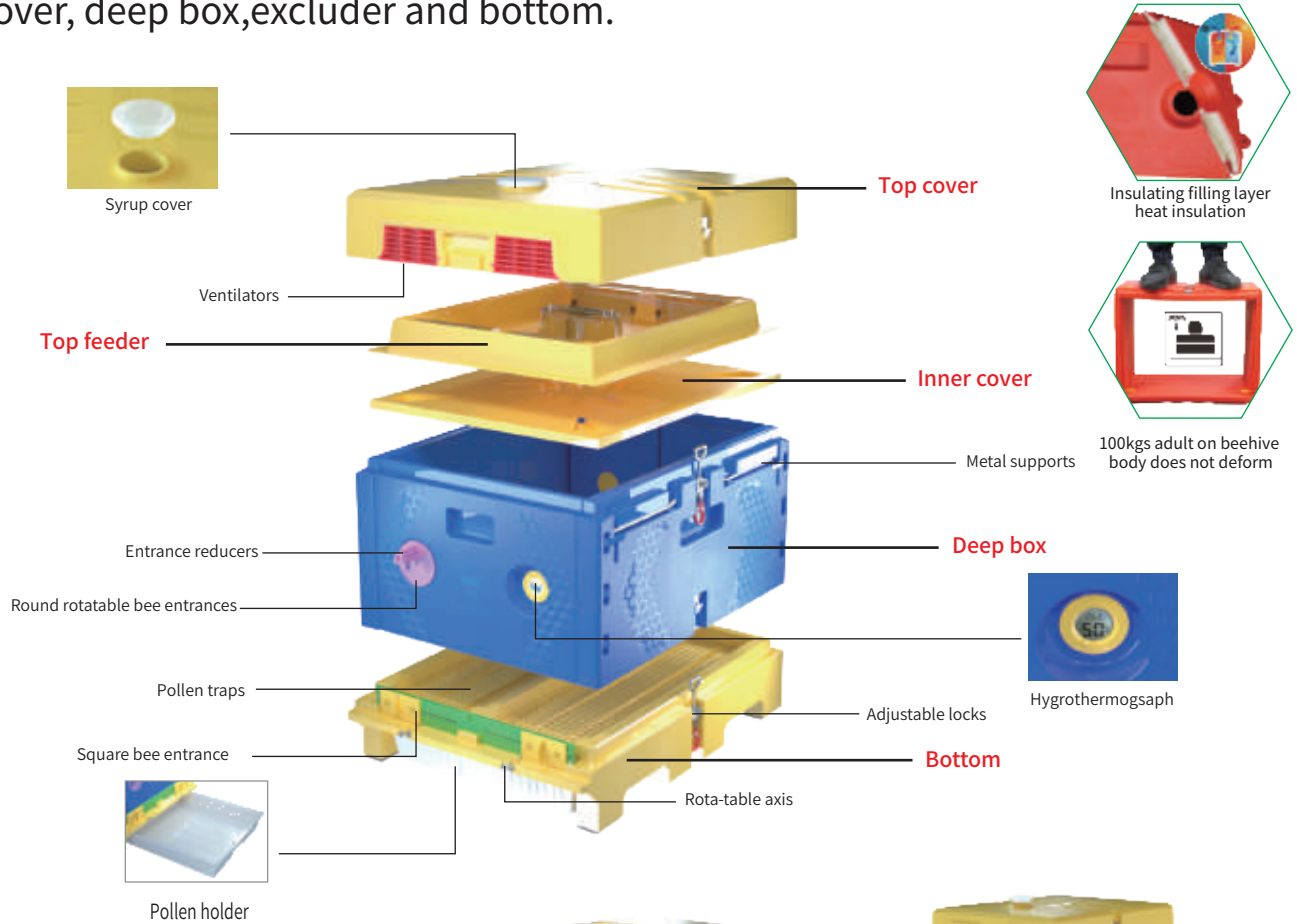

Model: H21

455mm*440mm*576mm(1 LAYER)

- 1 Top cover
- 1 Top feeder
- 1 Inner cover
- 1 Deep box
- 1 Bottom

Model: H21-2

700mm*440mm*576mm(2 LAYERS)

- 1 Top cover
- 1 Top feeder
- 1 Inner cover
- 2 Deep box
- 1 Excluder
- 1 Bottom

Model: H21-3

945mm*440mm*576mm(3 LAYERS)

- 1 Top cover
- 1 Top feeder
- 1 Inner cover
- 3 Deep box
- 1 Excluder
- 1 Bottom



Beehives

BB Plastic beehive

Material: HDPE
Standard Langstroth 10 frames

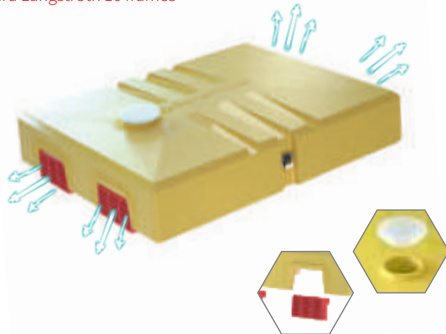

Model:HP17
BB Beehive outer cover

Material: PP
Size:365*40mm

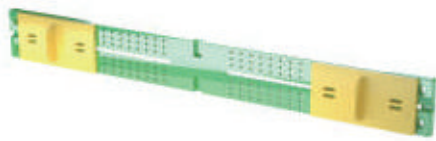

Model:HP19
BB Plastic slide beehive entrance

Material: HDPE
Standard Langstroth 10 frames

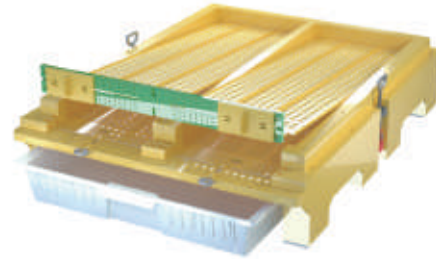

Model:HP18
BB Bottom board

Material: PP
Size:463x370x63mm
Capacity: 8L



Model:HP20
BB Pollen tray (8L)



(unassembled)

Model:H21-4
BB Plastic beehive box
Box inner size: 490x370x260mm
suitable for length 490 and 483mm



Deep box

There are grooves in the middle and at the two sides. While inserting PVC board or a wooden board, beekeeper can keep two queen bees.



Beehives



Model:H27L-P

Langstroth Beehive

Approximate weight: 10.66kg
 Material:EPS&plastic
 Size:575.5*440*460mm
 Foam density:150g

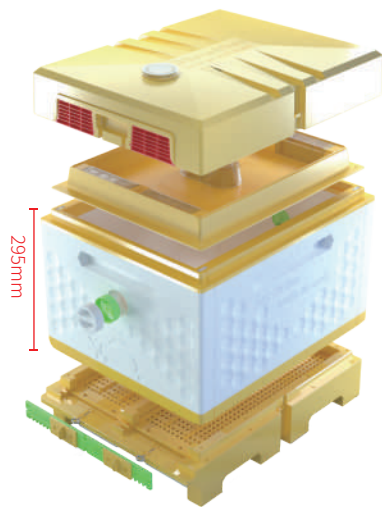
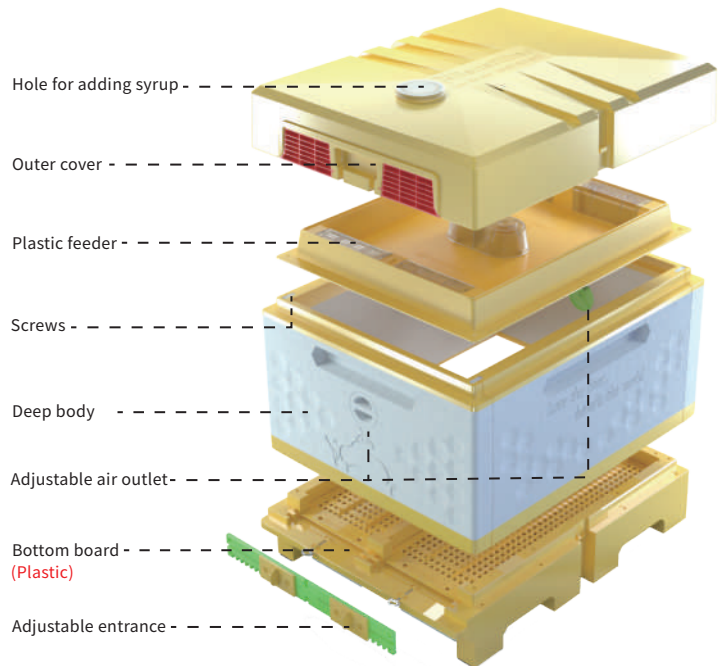

Model:H27D-P

EPS Dadant(US)Beehive

Approximate weight:11.2kg
 Material:EPS&plastic
 Size:575.5*440*513mm
 Foam density:150g

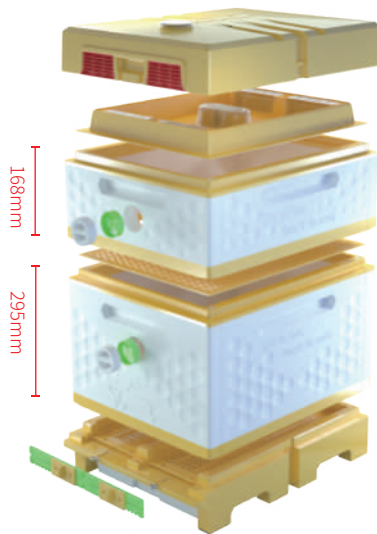

Model:H27D-2P

EPS Dadant(US)Beehive

Approximate weight:13.3kg
 Material:EPS&plastic
 Size: 575.5*440*688mm
 Foam density:150g

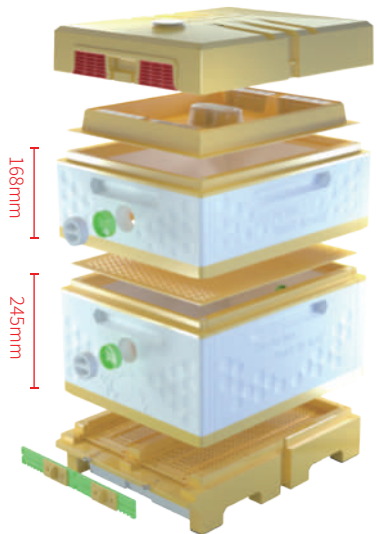

Model:H27L-2P

Langstroth Beehive

Approximate weight:13.3kg
 Material:EPS&plastic
 Size: 575.5*440*635mm
 Foam density:150g

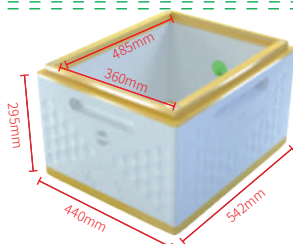

Langstroth 4/3 (Jumbo,Dandant,)

Model:H27-295

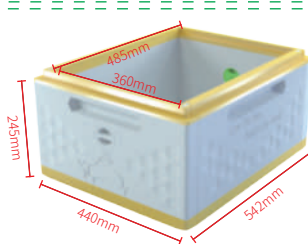

Langstroth 1/1

Model:H27-245

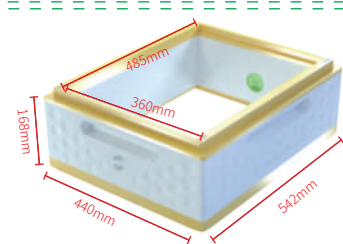

Langstroth 2/3

Model:H27-168

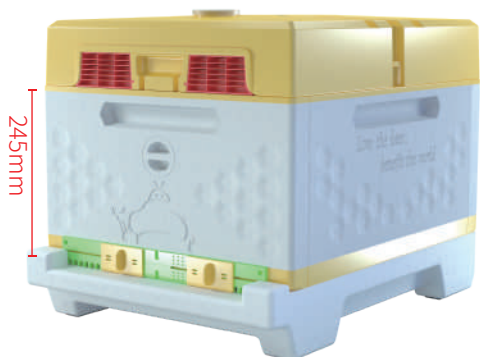

Model:H27L

Langstroth Beehive

Approximate weight:8.81kg
 Material:EPS&plastic
 Size:575.5*440*456mm
 Foam density:150g

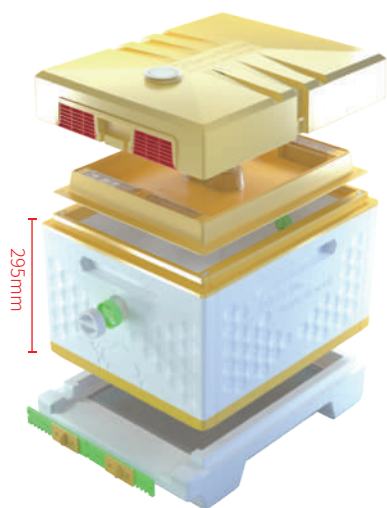
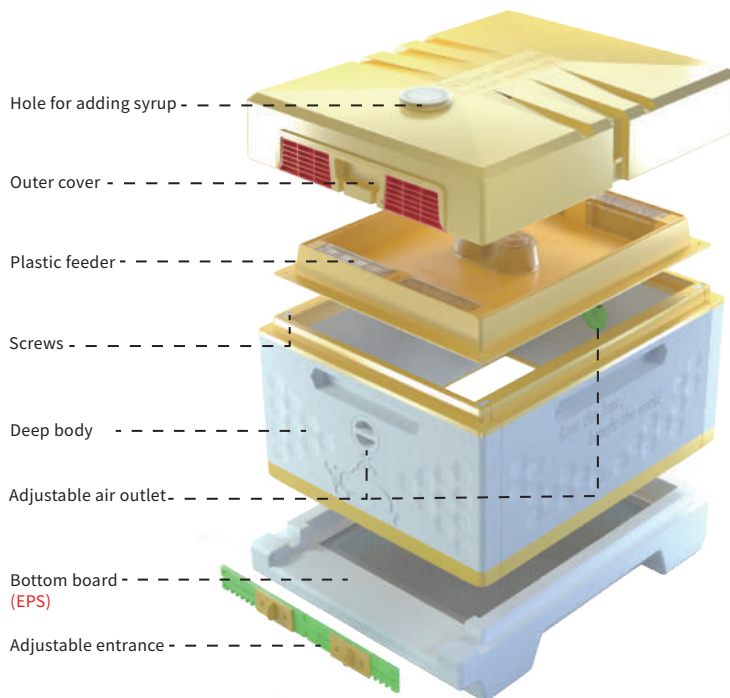

Model:H27D

EPS Dadant(US)Beehive

Approximate weight:9.35kg
 Material:EPS&plastic
 Size:575.5*440*509mm
 Foam density:150g

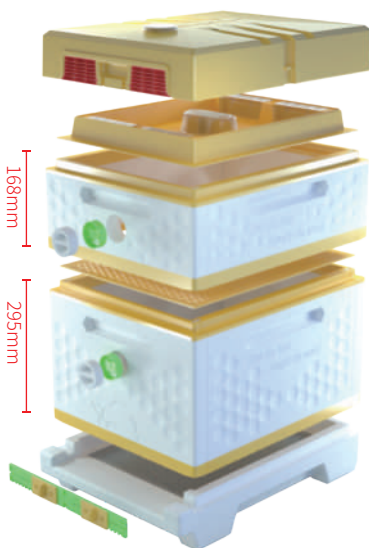

Model:H27D-2

EPS Dadant(US)Beehive

Approximate weight:12kg
 Material:EPS&plastic
 Size: 575.5*440*684mm
 Foam density:150g

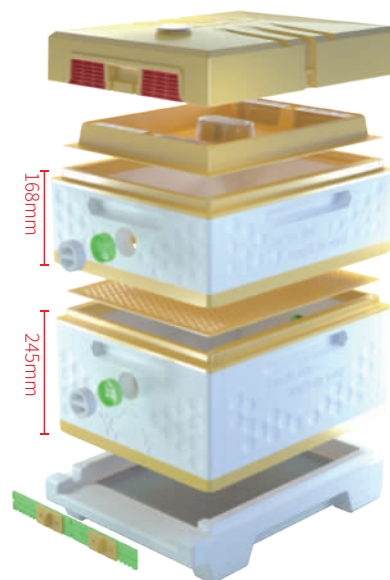

Model:H27L-2

Langstroth Beehive

Approximate weight:11.45kg
 Material:EPS&plastic
 Size:575.5*440* 631mm
 Foam density:150g



Beehives

Benefitbee®

BB polystyrene beehive

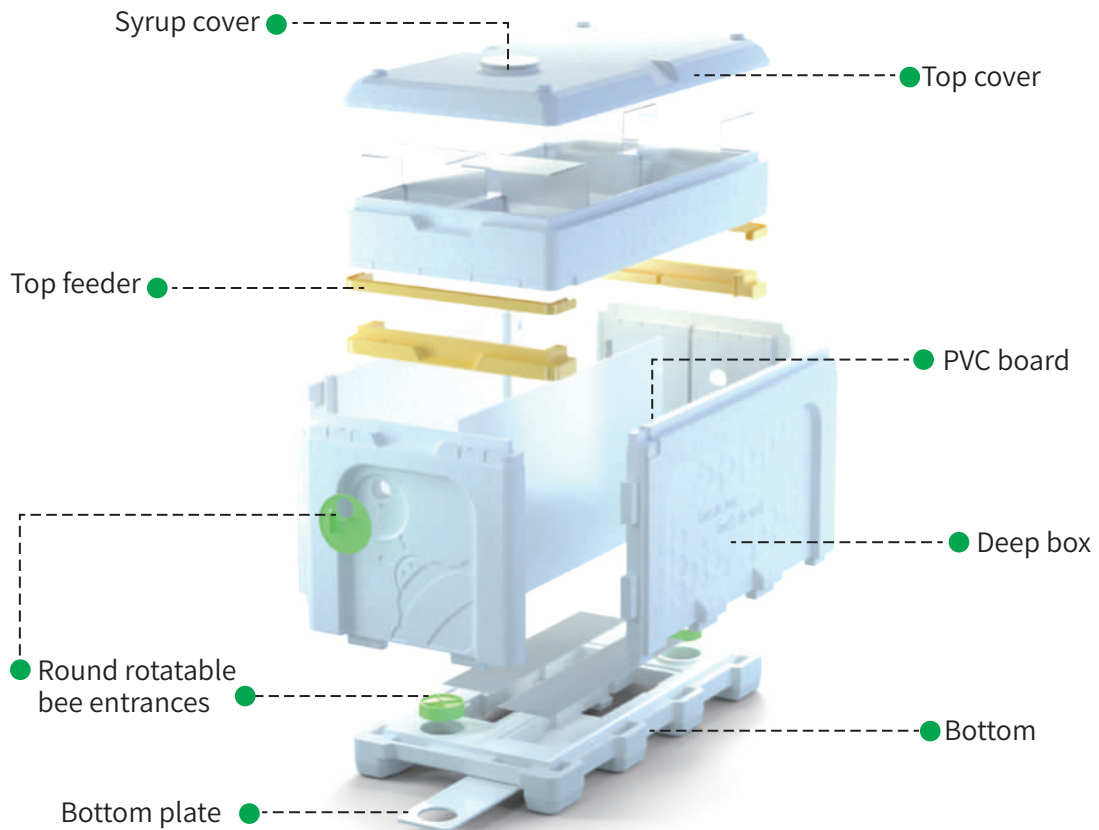

Model : H10-7

BB Queen mating box (6 frames)

Size: 530x285x408mm

Total weight: 3kg

Foam density: 120g

Material: EPS

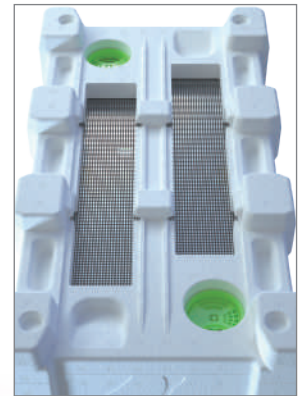

① EPS material colors

Imported materials

② Painted colors

Surface spray

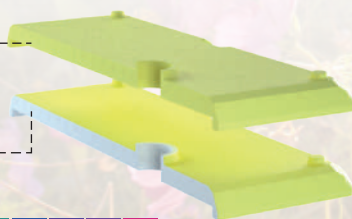

◆ 9 EPS material colors are available.



Beehives

Benefitbee®

BB Nuc box/Queen mating box

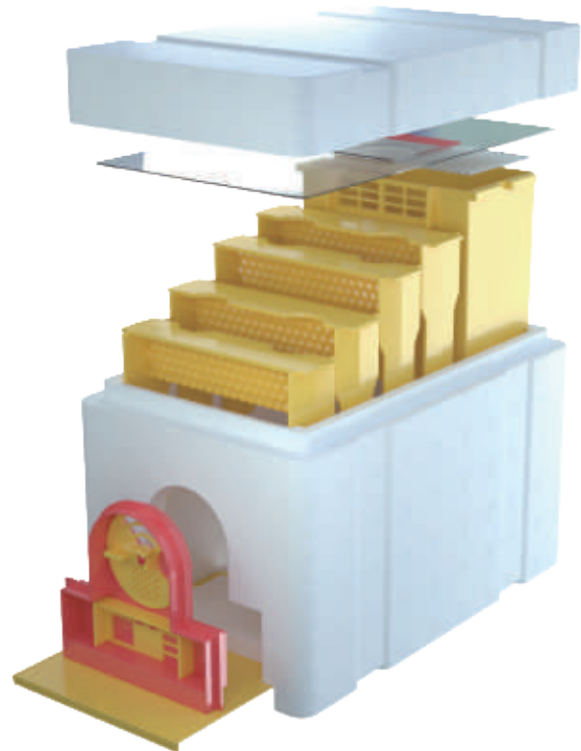

Model: H10-2

Size: 24x15x17cm

Material: EPS

Standard: 4 frames

Patent No.: 2021 3 0233864. 9

1 plastic feeder, 1 floating net, 1 PVC transparent observation film, plastic hive door + breathable bottom board, foam density 120g.

Queen mating box



Model: H10-3



Lid -top cover

Transparent viewing panel

Net (Prevent bees from drowning) - Beefeeders

Beehive entrance

Frame

Deep hive body

Beehive entrance sheet - round sheet

Beehive entrance sheet - square sheet

Bottom board

Bottom plate

Model: H10-3B

BB Plastic queen bee mating super box

Patent No.: 202130289413. 7

Material: HDPE

Size: 25.4x15.3x17.1cm

Standard: 4 frames

Optional Box color: blue, green, yellow



Beehives



BB Nuc box/Queen mating box

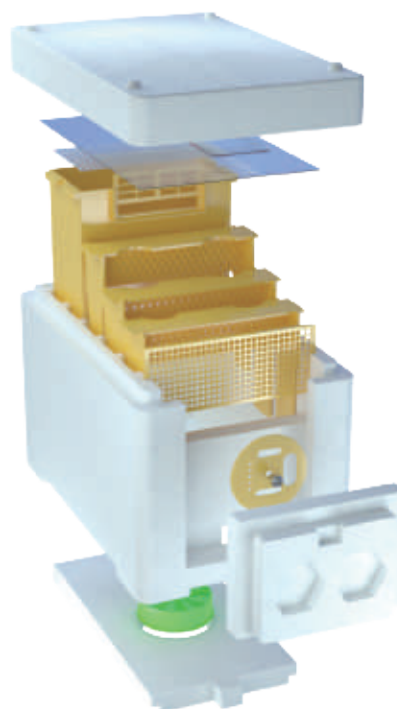

Model: H10-4

Patent No.:2021 23305122.6

Size:24x15x17cm,
material:EPS

Standard: 4 frames, 1 plastic feeder, 1 floating net, 1 PVC transparent observation film, plastic hive door + round plastic ventilators(5.5CM), foam density 120g.



Model: H19

Size:LWH: 366*197*259mm

Material:PP



Model: H19-2

Material: Tinplate size
Diameter x height 10*14cm

Bee package

Appearance Patent No.: 202030137781.5
Utlity Model Patent No.: 202020512338. 6

- 1.The Bee Cage have a good protective for Bees in the long-distance transportation.It' s suitable for mailing package and bee transfer place.
- 2.The Bee Cage' s up and down can be connected to each other, transport more firmly.
- 3.Large Capacity,ventilation de sign,foldable and assemble easily.
- 4.With a feeding can, which can be repeated use.

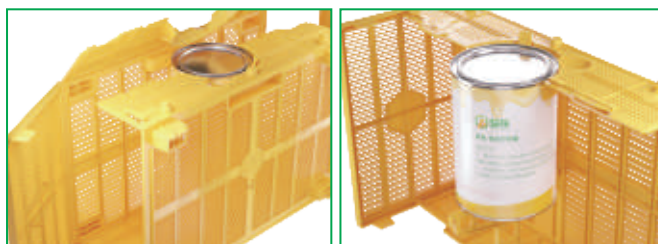



Beehives

Langstroth Beehive Kit



Model: H22-2

Langstroth Beehive Kit

(2 deep box+1 super box)

Langstroth Beehive 10 Frames Standard

- 1 large iron cover
- 1 inner cover
(marked with oval holes)
- 1 super box
(505 * 413 * 168)mm
- 2 deep box
(505 * 413 * 245)mm
- 1 bottom board
- 1 excluder
(510x410)mm
- 20pcs wax sprayed black foundations
(425x210)mm
- 10pcs wax sprayed yellow foundations
(425x141)mm
- 10pcs first-class pine big frames
(Pinus sylvestris without scab 483x232)mm
- 20pcs first-class pine small frames
(Pinus sylvestris without scab 483x159)mm

Material:

Chinese Fir with knot splicing board, the beehive is boiled twice with Paraffin, the first step is boiled for about 3.5 mins.



Model: H22

Langstroth Beehive Kit

(1 deep box+1 super box)



Model: H22-3

Langstroth Beehive Kit

(2 deep box+2 super box)



Model: H22-4

Langstroth Beehive Kit

(1 deep box+4 super box)



Beehives

Benefitbee®

Plus queen mating nuc box >>

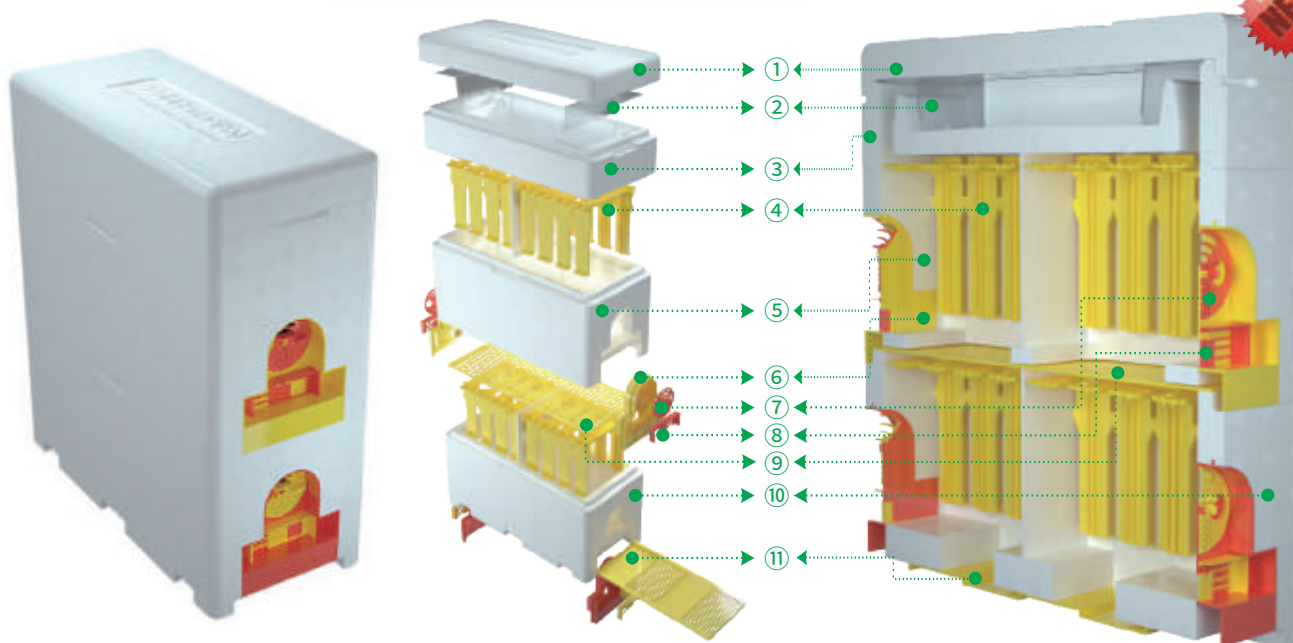

Model: H18

Patented product

Patented no. 201910754536.5

Patented no. 201930438030.4

Patented no. 201921324972.0

- 1、Lid –top cover
- 2、Syrup excluder (one front and one back)
- 3、Lid-bottom cover
- 4、Frame (three of one group)
- 5、Shallow super
- 6、Beehive Entrance panel
(Assembled with entrance sheet, three of one group)
- 7、Beehive entrance sheet- round sheet
(assemble with entrance panel, three of one group)

- 8、Beehive entrance sheet- square sheet
(assemble with entrance panel, three of one group)
- 9、Queen excluder
- 10、Deep hive body
- 11、Bottom plate

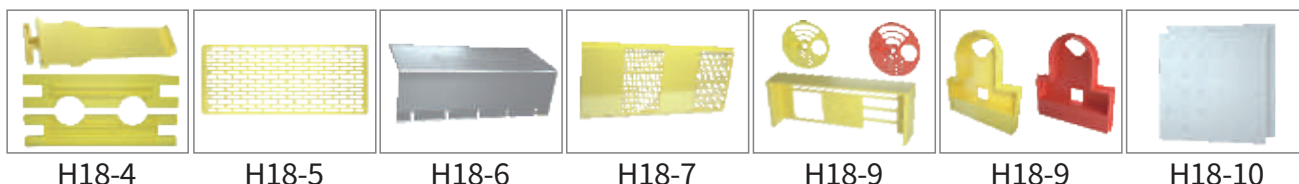

H18		Standard including : Lid, Feeder, Super box, Deep box Accessories: 16pcs plastic frame, 2pcs syrup excluder, 4pcs plastic entrance panel (red and yellow each 2pcs), 2pcs round entrance sheet, 2pcs square entrance sheet, 1pc bottom board, 1pc queen excluder, 2pcs PVC foam clapboard, Size:328mm*148mm*363mm
H18-2		Standard including : Lid, Feeder, Deep box Accessories: 8pcs plastic frame, 2pcs syrup excluder, 2pcs plastic entrance panel (red and yellow each 1pc), 1pcs round entrance sheet, 1pcs square entrance sheet, 1pc bottom board 1pc PVC foam clapboard, Size:328mm*148mm*230mm
H18-3		Standard including : Super box Accessories: 8pcs plastic frame, 2pcs syrup excluder, 2pcs plastic entrance panel (red and yellow each 1pc), 1pcs round entrance sheet, 1pcs square entrance sheet, 1pc bottom board, 1pc PVC foam clapboard, Size:328mm*148mm*143mm



Model: H02(10 frame) H02-2(8 Frame)

Australian beehive

Standard configuration(Australia beehive):

- 1*Outer cover(With metal)
- 1*Deep hive body(L505*W405/355*H242*20mm)
- 1*Shallow super(L505*W405/355*H146*20mm)
- 1*Bottom board (With Entrance)

Material:

- New Zealand pine/Pinus sylvestris
- China fir (Unassemble)



Model: H01(10frame) H01-2(8 Frame)

Langstroth beehive

Standard configuration(Langstroth beehive):

- 1*Outer cover(With metal)
- 1*Inner cover(L505*W413/355mm)
- 1*Deep hive body(L505*W413/355*H245*20mm)
- 1*Shallow super(L505*W413/355*H168*20mm)
- 1*Bottom board (With Entrance)

Material:

- New Zealand pine/Pinus sylvestris
- China fir (Unassemble)



Beehives



Available material: China Fir, European Pine, China Pine and New Zealand Pine.
Available size: 8 frame and 10 frame



H02-2
Australia beehive
(Waxed+ painted)



H03
Italy beehive
(2 Layers 10 frames)



H04
Langstroth queen rearing
box (4 or 5 frames)



H04-2
5er Zander Ableger



H06
Nuc bee box



H06-2
Nuc bee box
(Calcium plastic)



H06-5
Nuc Mesh
Transport Bag



H07
Multifunctional
plastic beehive



H10-5
Queen mating box
(120 g density)



H10-6
Queen mating box
(120 g density)



H10
Queen bee mating box



Beehives



Red cedar

H11
UK style beehive



Red cedar

H12
UK WBC beehive



H13
Japan style beehive



H14
Kenyan Hive



H17
Observation hive



H26
Kenya Set Beehive

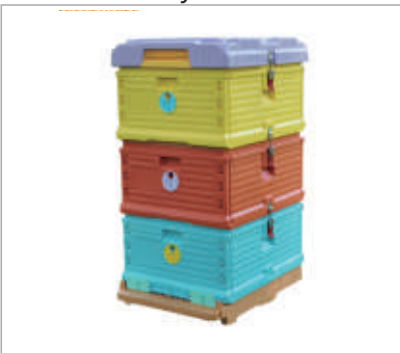

H20
Plastic beehive



(one bottom and two successors)

H24
Ten-Frame Dadant Beehive



three floors

H25
Ten-frame Zander beehive



H08
Double layer plastic beehive



H09
Insulated beehive



IH01
Insect house



IH02
Insect house



Beehive parts



CNT:10PCS New Zealand pine

(Langstroth\Australia
\8\10frames can be chosen)
Ventilated hole could be customized.

HP01

CNT:20PCS New Zealand pine

(8frames\10frames can be chosen)

HP02

CNT:18PCS ABS

355X 13 X 505mm(8 frame)
405X 13 X 505mm(10 frame)
Optional size in free term

HP02-3

CNT:20PCS New Zealand pine
(Splicing wood)

Board thickness:20mm

HP03

CNT:10PCS New Zealand pine+
Plywood

(8frames\10frames can be chosen)

HP04

CNT: 5PCS New Zealand pine

(8frames\10frames can be chosen)

HP05

CNT:2PCS New Zealand pine

(8frames\10frames can be chosen)

HP05-2

CNT: 5PCS New Zealand pine
(spray paint)

(8frames\10frames can be chosen)

HP05-3

CNT: 5PCS PP

575*420*340mm
(8frames\10frames can be chosen)

HP06/HP06-2

CNT:10PCS Iron with spray paint

60X50X62CM(customizable)

HP06-3

CNT: 5PCS Stainless steel 201

Size: customizable

HP06-4

CNT: 1PCS Galvanized

Size: customizable

HP06-5



Beehive parts

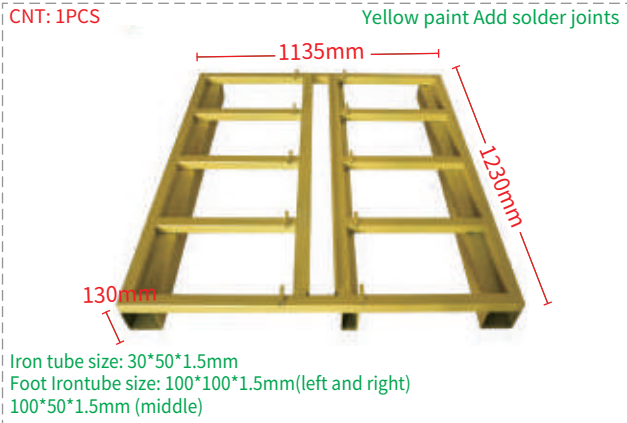

HP09

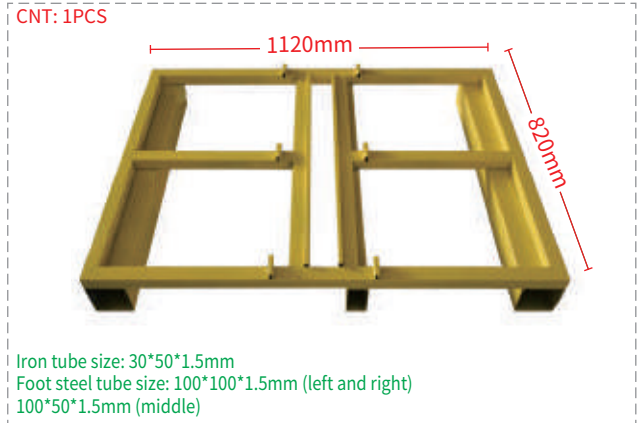

HP09-2

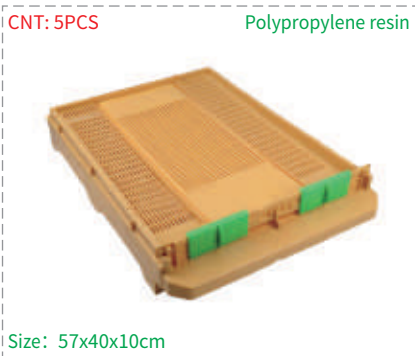

HP07



HP07-2

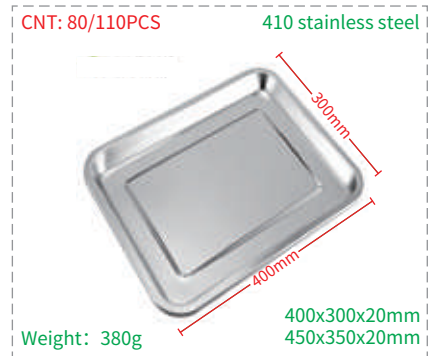

HP08/HP08-2

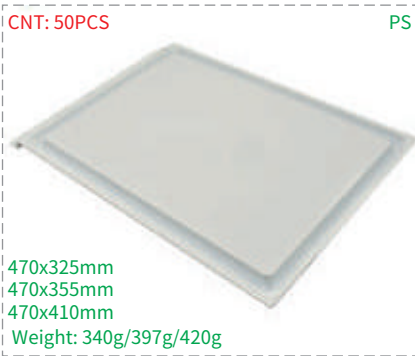

HP08-3/HP08-4/HP08-5



HP09-3



HP16/HP16-2



HP12
Risers



HP13
Cleats

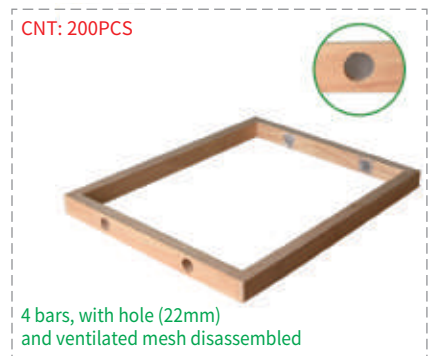

HP14
Rims



Beehive entrance >>

<p>CTN:200PCS</p> <p>HA05</p>	<p>CTN:1000PCS</p> <p>SUS201 Size:50mm</p> <p>HA09-6B</p>	<p>CTN:2000PCS</p> <p>Size:50mm</p> <p>HA09-8</p>	<p>CTN:2000PCS</p> <p>Size:50mm</p> <p>HA09-9</p>	
<p>CTN:200PCS</p> <p>SUS201 Size:125mm</p> <p>HA09B</p>	<p>CTN:10000PCS</p> <p>Size:50mm</p> <p>HA09-3</p>	<p>CTN:2500PCS</p> <p>Plastic Size:68mm</p> <p>HA09-4</p>	<p>CTN:1200PCS</p> <p>Plastic Size:68mm</p> <p>HA09-5</p>	
<p>CTN:10000PCS</p> <p>PP Size:50mm</p> <p>HA09-6</p>	<p>CTN:1000PCS</p> <p>PP Size:125mm</p> <p>HA09-7</p>	<p>CTN:200PCS</p> <p>Galvanized iron Size:125mm</p> <p>HA09</p>	<p>CTN:1000PCS</p> <p>SUS201 Size:68mm</p> <p>HA09-2</p>	
<p>CTN:300PCS</p> <p>PP</p> <p>315x40mm 370x40mm 450x40mm</p> <p>HA06</p>	<p>CTN:200PCS</p> <p>PP</p> <p>189mm</p> <p>HA07</p>	<p>CTN:300PCS</p> <p>Plastic</p> <p>148mm 52mm 130mm 55mm</p> <p>HA08</p>	<p>CTN:500PCS</p> <p>Iron</p> <p>480*35mm/450*35mm/ 400*35mm/380*35mm/ 375*35mm/350*35mm/ 300*35mm/250*35mm/ 220*35mm/180*35mm/ 160*35mm</p> <p>HA01</p>	<p>CTN:200PCS</p> <p>Iron</p> <p>165*27mm 200*27mm 250*27mm 300*27mm 350*27mm 275*27mm Galvanized product</p> <p>HA04-3</p>
<p>CTN:540PCS</p> <p>Iron</p> <p>480*35mm/450*35mm/ 400*35mm/380*35mm/ 375*35mm/350*35mm/ 300*35mm/250*35mm/ 220*35mm/180*35mm/ 160*35mm</p> <p>HA02</p>	<p>CTN:300PCS</p> <p>Galvanized iron</p> <p>250mm 30mm</p> <p>HA03</p>	<p>CTN:100PCS</p> <p>Iron plating</p> <p>390X65mm/335X65mm</p> <p>HA04</p>	<p>CTN:300PCS</p> <p>Stainless steel</p> <p>390X65mm/335X65mm</p> <p>HA04-B</p>	<p>CTN:50/70PCS</p> <p>Galvanized iron</p> <p>Anti-robbing (8/7 holes) Length:350mm/410mm</p> <p>HA23/HA23-2</p>



Hive accessories

Frame support >>



HA34
Frame support
CTN:40PCS



HA34-2
Frame support
CTN:40PCS



HA34-3
Frame support
CTN:40PCS

Escape >>

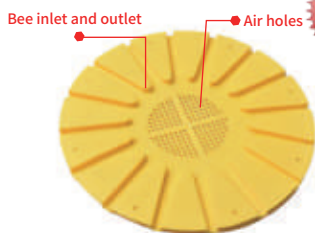

Model: HA25-2
16 ways bee escape
CTN:100PCS

CTN:100PCS



HA25

CTN:100PCS



HA26

CTN:200PCS



HA26-2

CTN:140PCS



HA27

CTN:2500PCS



HA28

CTN:450PCS



HA29

CTN:1600PCS



HA30

CTN:3000PCS



HA31

CTN:450PCS



HA24

Frame fixator >>



HA16
(450x22mm)
(10/11/12 frame)
CTN:1000PCS



HA16-2
(375x22mm)
(8/9/10 frame)
CTN:1000PCS



HA14
(370x31mm)
(10 frame)
CTN:500PCS



HA14-2
(370x21mm)
(9 frame)
CTN:1000PCS



HA14-3
(375x21mm)
(10 frame)
CTN:1000PCS



HA14-4
(450x21mm)
(10 frame)
CTN:1000PCS



HA15-1/2
(450/375mm)
CTN:1000PCS



Connector & handle >>



CTN:200PCS
HA21-2
Beehive connector



CTN:50PCS
HA17
Spring fastener



CTN:50PCS
HA17-2
Spring fastener



CTN:50PCS
HA17-3
Spring fastener
(line diameter 4mm)



CTN:200PCS
HA21
Beehive connector
improved type



CTN:600PCS
HA20
Beehive angle
clamp



CTN:150PCS
HA22
Beehive handle



CTN:200PCS
HA22-2
Beehive handle



CTN:100PCS
HA22-3
Beehive handle



CTN:500PCS
HA33
Plastic beehive
fixator (Snap fastener)

Other accessories >>



HA32
Beehive number mark
CTN:720PCS



HA32-2
Beehive number mark
CTN:600PCS



HA32-3
Beehive number mark
CTN:500PCS



HA32-4
Hive number mark
CTN:80PCS



HA46
Antproof stand
CTN:150PCS



HA19
Anti-glare film
CTN:150PCS
Size:500*270/ 500*430



HA13
Foam beehive
plastic bottom plate
CTN:1120PCS



HA44
Stainless steel net
CTN:100PCS
Size:can be customized



HA45
Galvanized hive cover
CTN:5PCS
Size:can be customized

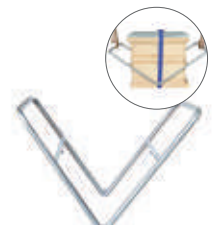

HA47
Beehive carry
CTN:5PCS
Material: galvanized iron



Frames



Model: F25

BB Comb honey frame

483*227*42mm
(three layers)

483*159*42mm
(two layers)

Without honey comb cassettes

Patent No.:202030368092. 5

Patent No.:202030783832. 1

CTN: 20/40PCS



Model: F25-3

BB Honey comb cassettes 250g

106.5*68*36 mm

Material: PS

patent No.:202030368092. 5

patent No.:202030783832. 1

CTN: 150PCS

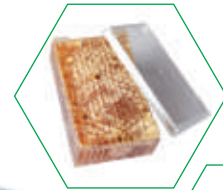
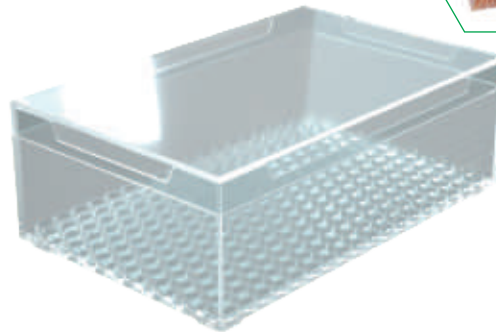



Frames

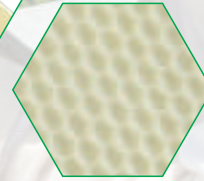
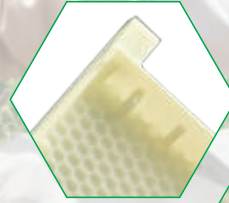
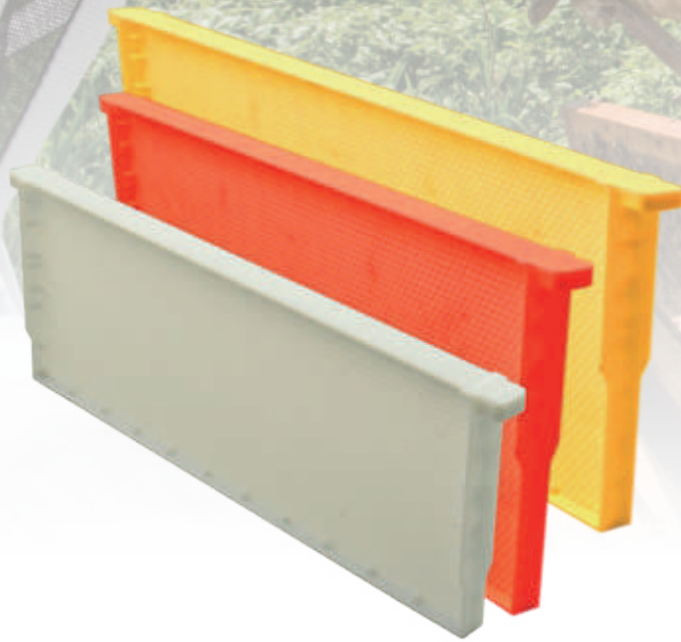

Model: F06

Plastic frame with comb foundation

- Anti-beetles design
- ABS Food Grade
- 483*232mm
- 483*175mm
- 483*159mm

CTN: 20PCS

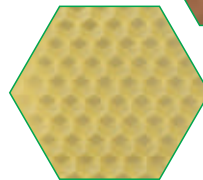

Model: F04

Assembled frame with wax sheet

Material: New Zealand pine without knot
SUS 201, 30% beeswax foundation sheet

483*232/159/136*36mm

Other size could be customized

CTN: 20PCS

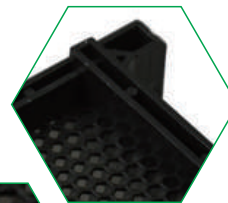

Model: F07

Plastic frame with comb foundation

- Material: ABS
- 483*232mm
- 483*175mm
- 483*159mm
- 483*125mm

CTN: 50PCS



Frames



CTN: 20PCS

F02-2

Assembled wood frame with plastic foundation sheet

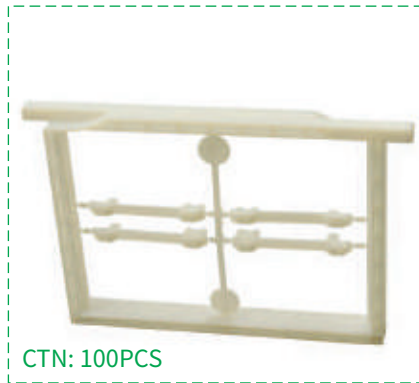

CTN: 100PCS

F20

Plastic frame for mating nuc box



CTN: 20PCS

F24

Plastic combination frame



CTN: 60/88PCS

F21/F22

Honey comb (Large/Small)



CTN: 100PCS

F26

Comb honey frame fixer

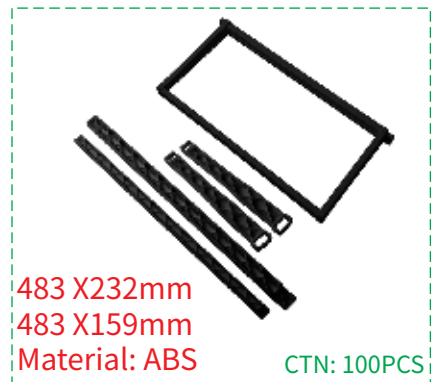

CTN: 100PCS

F23

BB Plastic combination frame



CTN: 1PCS

F28

Pollen frame
Match with F27

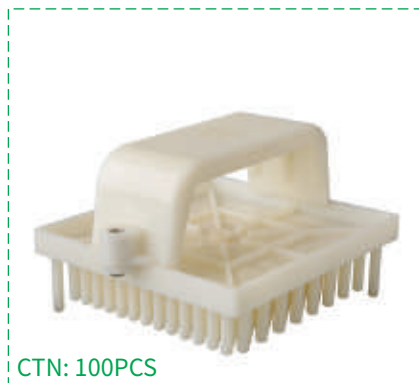

CTN: 100PCS

F28-2

Pollen frame
Match with F27



CTN: 400PCS

F27

Pollen collector
Match with F27 or F28-2



Frames



OEM/ODM available >>



CTN: 100PCS

F01
Unassembled langstroth frame
483X232/159/136X36mm



CTN: 20PCS

F02
Assembled langstroth frame
483X232/159/136X36mm



CTN: 20PCS

F03
Wired langstroth frame
483X232/159/136X36mm

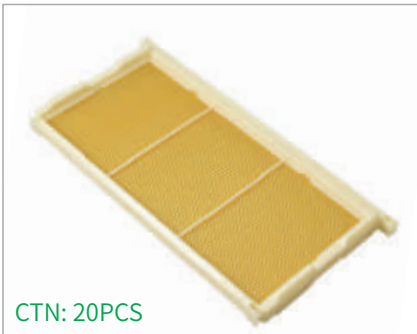

CTN: 20PCS

F09
Detachable plastic frame
485X235X28mm



CTN: 19PCS

F18 (With cage)
Queen bee rearing frame
483*232mm (Customize size available)



CTN: 3200PCS

F15
Frame spacer
Weight:5.5g



CTN: 40PCS

F10
250g comb honey frame
483X240X448mm



CTN: 150PCS

F10B
Comb honey box 250g
104X72X42mm



CTN: 40PCS

F11
500g comb honey frame
483X228X448mm



CTN: 100PCS

F11B
Comb honey box 500g
141X99X44mm



CTN: 15PCS

F12
Heart-shaped comb honey frame



CTN: 200PCS

F12B
Fully transparent heart-shaped comb honey box

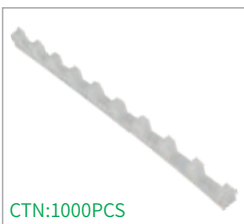

CTN:1000PCS

F13
Plastic frame spacer
Material:PP



CTN:260PCS

F14
Frame ranging tool (9frames)
Material:ABS



CTN:220PCS

F14-2
Frame ranging tool (7frames)
Material:ABS



CTN:260PCS

F14-3
Frame ranging tool (8 frames)
Material:ABS



CTN:100PCS

F14-4
9 frames metal spacing tool
Material:SUS201



Comb foundation



OEM/ODM available >>

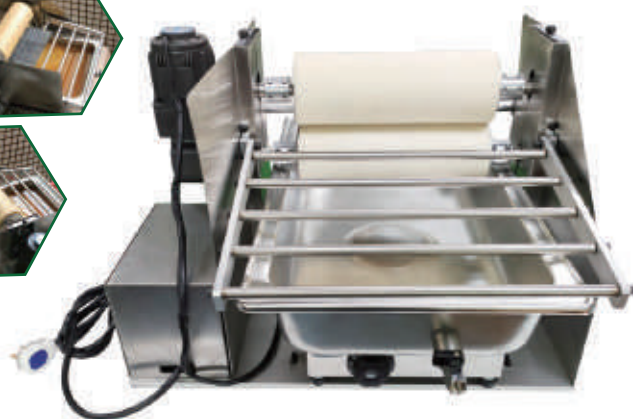
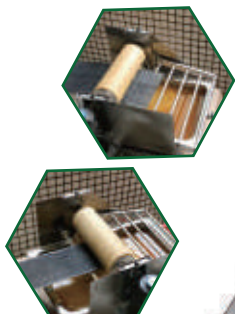

Model : CF07

BB Plastic foundation
wax roller machine

Size: 470*590*420mm

Material: Stainless steel

Patented product

Appearance Patent No.:202230075247.5

Utility Model PatentNo.:202220388560.9



Material:PP
425*210mm
425*155mm
425*125mm

CTN: 200PCS

Model: CF02

Plastic comb foundation
(Rotational molding)

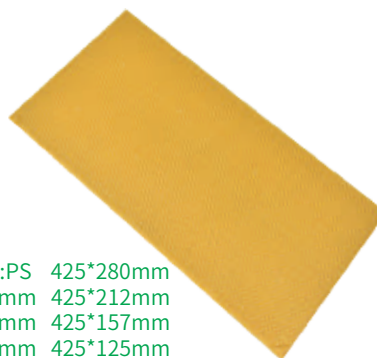

Material:PS 425*280mm
425*212mm 425*212mm
425*161mm 425*157mm
425*141mm 425*125mm
425*121mm 425*115mm

CTN: 200PCS

Model:CF03

Plastic comb foundation
(Injection molding)



Material:ABS
425*212mm
425*141mm
Color: yellow

CTN: 100PCS

Model : CF06

Plastic comb foundation
(Injection molding)



CTN: 30PCS

Model: CF01

Pure beeswax content: 30%~100%
Ceus size:4.75~5.4mm
(Customized)



Economy wire tools



OEM/ODM available >>

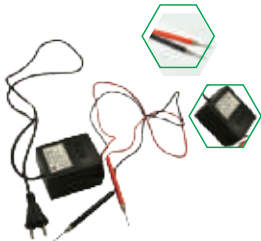

Model: WT01-9
Electric wire embedder



Model: WT01-8
Electric beeswax foundation embedder



Model: WT01-11
Plastic handle Spur wire embedder

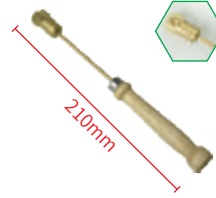

Model: WT01-4
Spur wire embedder



Model: WT01-12
Wire embedder(Electric)



Model: WT01-6
● Patented product
BB wire embedder
(Electric)



Model: WT01-5
● Patented product
Electric wire embedder



Model: WT02-3B
● Patented product
BB Wire crimper(Stainless)



Model: WT02
Bee frame tensioner



Model: WT01-13
Wire embedder



WT01
Economy wire embedder



WT01-3
Wire embedder



WT01-2
Wire embedder

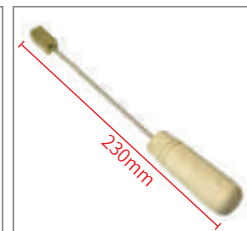

WT01-7
Wire embedder



WT01-10
Spur embedder



WT02-2
Bee frame tensioner



WT02-4
Bee frame tensioner



WT02-6
Wire crimper
(Stainless)



WT05-2
Wood handle needle



WT05-3
Plastic handle needle



WT08
Beeswax septum knife



WT04
Wire pilers

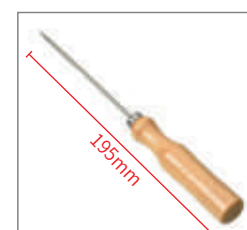

WT05
Needle

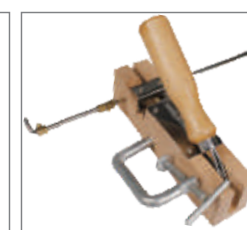

WT06
Frame puncher



WT06-2
Frame puncher



Economy wire tools



Model: WT13

Pure copper eyelet (1KG/BAG)

- Size: 4.5mm X 2.5mm X 2.5mm
6mm X 5mm X 3mm
- CTN: 50PCS



Model: WT14

Iron eyelets(1KG/BAG)

- Size: 4.5mm X 4.5mm X 2.5mm
6.5mm X 5mm X 3mm
- CTN: 25PCS



Model: WT15

304 stainless steel eyelets(1KG/BAG)

- Size: 4.5mm X 4.5mm X 2.5mm
6.5mm X 5mm X 3mm
- CTN: 25PCS



Model: WT07-2

Frame threading rack

- Material: IRON
- CTN: 14PCS



Model: WT16

Foundation clip nail(1000pcs/bag)

- Width: 0.55cm
Length: 2.55cm
Opening: 0.25cm
- CTN: 10PCS



Frame wires

Model	Material	Wire diameter	Gram
WT10	Galvanized	0.55/0.4mm	250g, 500g, 1000g
WT11	SUS201	0.55/0.4mm	250g, 500g, 1000g
WT12	SUS304	0.55/0.4mm	250g, 500g, 1000g



WT03

Wire cutter
CTN: 200PCS



WT03-2

Wire fixator
CTN: 50PCS



WT03-3

Wire cutter
(Wooden shaft)
CTN: 40PCS



WT07

Frame threading rack
CTN: 14PCS



Bundle tools



Model: BT01
Beehive cargo lashing
Rope length:5M
CTN: 50PCS



Model: BT01-2
Beehive cargo lashing with hook
Rope length:5M
CTN: 42PCS



Model: BT03
Metal beehive tie down strap
Rope length:10M
CTN: 10PCS



Model: BT02-4
Beehive tie strap(Australian)
Rope length:5M
CTN: 25PCS



Model: BT02
Metal beehive tie down strap
Rope length:5M
CTN: 25PCS



Model: BT02-2
Nylon beehive cargo lashing
Rope length:5M
CTN: 20PCS



Model: BT04
Beehive tie-down strap (Australia style)
Rope length:5M
CTN: 100PCS



Model: BT09
Beehive tie strap(304)
Rope length:3M
CTN: 60PCS



Model: BT06
Beehive tie-down strap (Green with hook)
Rope length:1.25M
CTN: 240PCS



Model: BT07
Beehive tie-down strap (American style)
Rope length:3M
CTN: 50PCS



Model: BT08
Beehive tie-down strap (European style)
Rope length:5M
CTN: 60PCS



Queen excluders

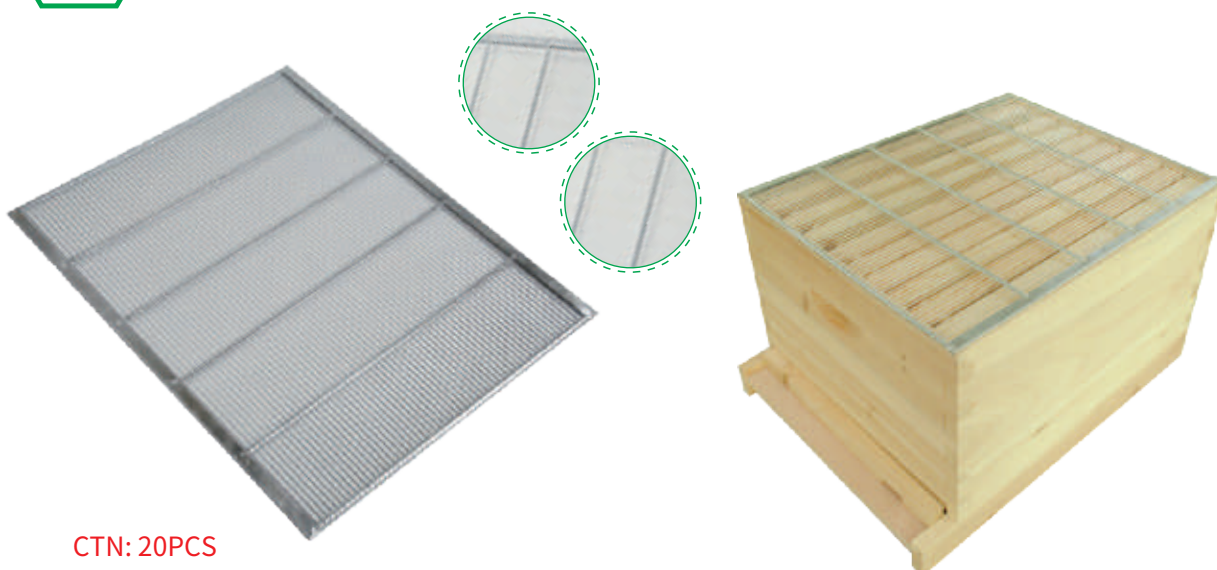

CTN: 20PCS

Model: EC01-2

American style metal queen excluder

Standard size: 510x410mm (10 frames)
510x360mm (8 frames)

The material or sizes can be customized as per customer's request

Galvanizing, Chromium plating, stainless steel materials are available. Precision wire spacing ensures your queen stays in the brood chamber. Product is highly durable and very easy to use. Able to supply all excluder sizes up to 550*600mm.

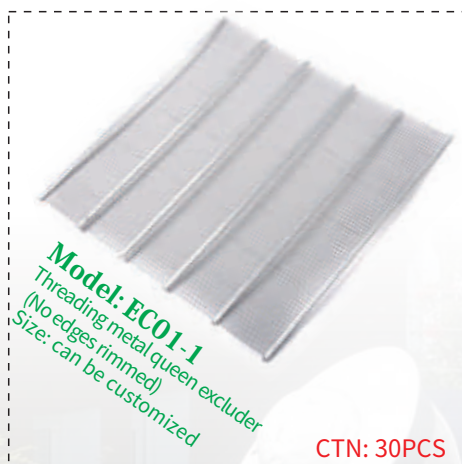

Model: EC01-1
Threading metal queen excluder
(No edges rimmed)
Size: can be customized

CTN: 30PCS

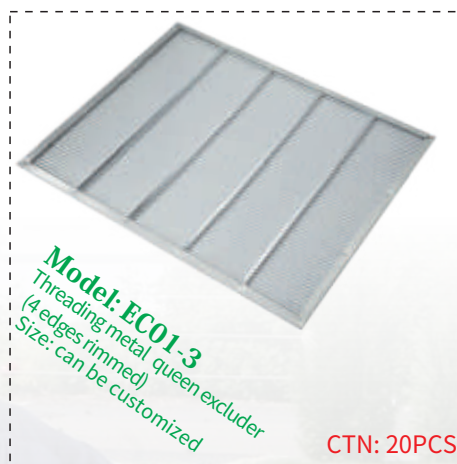

Model: EC01-3
Threading metal queen excluder
(4 edges rimmed)
Size: can be customized

CTN: 20PCS



Model: EC01-4
Metal queen excluder
(4 edges wooden)
Size: can be customized

CTN: 25PCS



Model: EC01-5
Threading metal queen excluder
(4 wide edges rimmed)
Size: can be customized

CTN: 20PCS



Model: EC01-6
US style queen excluder
(4 wide edges rimmed)
Size: can be customized

CTN: 20PCS



Queen excluders

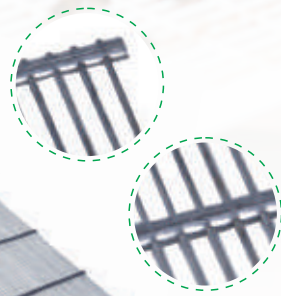
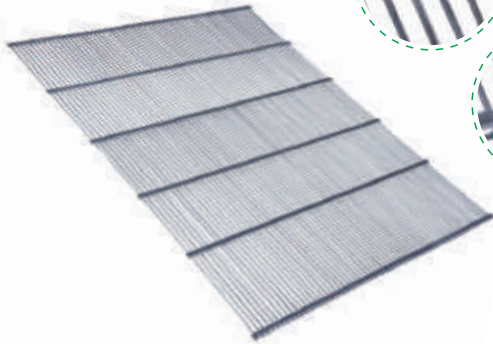

Model: EC02/EC02B

Style queen excluder (No edges rimmed)
Material: SS304 or SUS201
Wire diameter: 1.9mm
Clearance: 4.2mm
CTN: 20PCS

The material or sizes can be customized as per customer's request

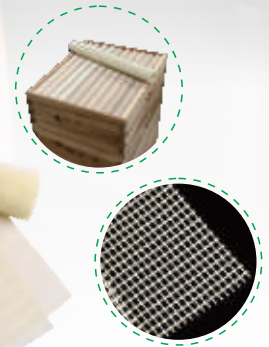

Model: EC09-3

Propolis collector
Material: PVC
Aperture: 1.5*1.5mm
Single weight: 45g
CTN: 1000PCS

Galvanizing, Chromium plating, stainless steel materials are available. Precision wire spacing ensures your queen stays in the brood chamber. Product is highly durable and very easy to use. Able to supply all excluder sizes up to 550*600mm.

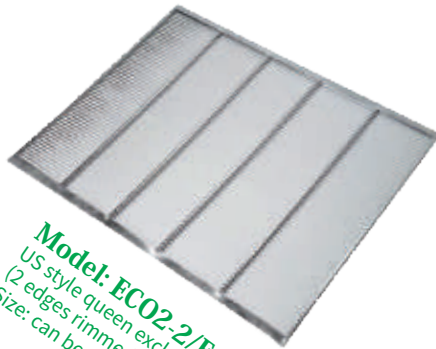

Model: EC02-2/EC02B-2
US style queen excluder
(2 edges rimmed) SUS304/SUS201
Size: can be customized

CTN: 20PCS

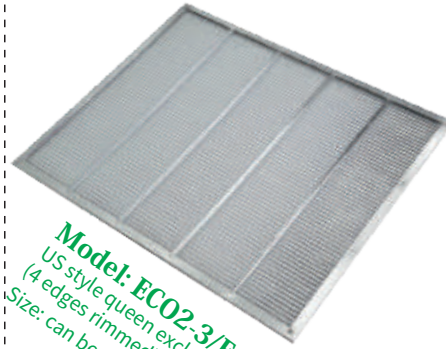

Model: EC02-3/EC02B-3
US style queen excluder
(4 edges rimmed) SUS304/SUS201
Size: can be customized

CTN: 20PCS

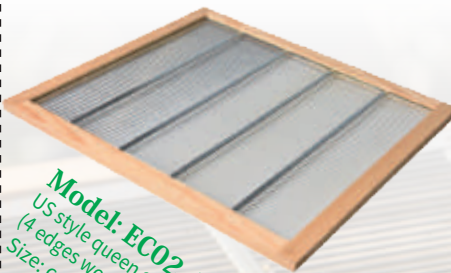

Model: EC02-4/EC02B-4
US style queen excluder
(4 edges wooden) SUS304/SUS201
Size: can be customized

CTN: 20PCS



Model: EC02-5/EC02B-5
US style queen excluder
(4 wide edges rimmed)
SUS304/SUS201
Size: can be customized

CTN: 20PCS



Queen excluders

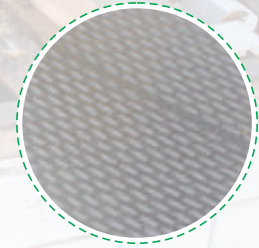
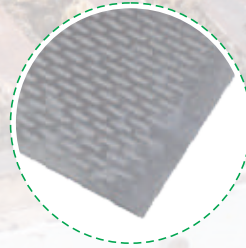

Model: EC03

CTN: 50PCS

Aluminium queen excluder

Made of durable, high-quality Aluminium. This unit is very sturdy and with smooth surface and edges which bees pass through comfortably.

● Sizes can be customized

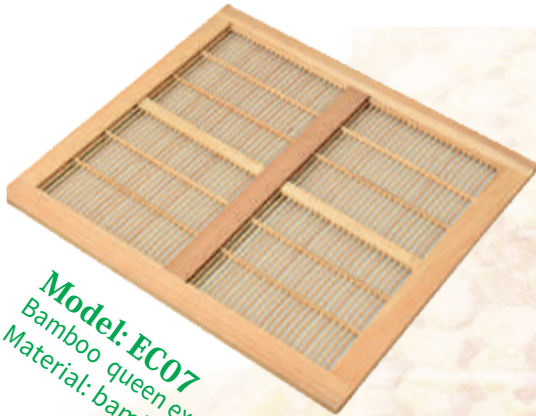

Model: EC07
Bamboo queen excluder
Material: bamboo

CTN: 25PCS



Model: EC07-3
Bamboo queen excluder
Material: bamboo

CTN: 50PCS



Model: EC08
Plastic queen vertical excluder
Material: ABS
Size: 490X260mm

CTN: 40PCS

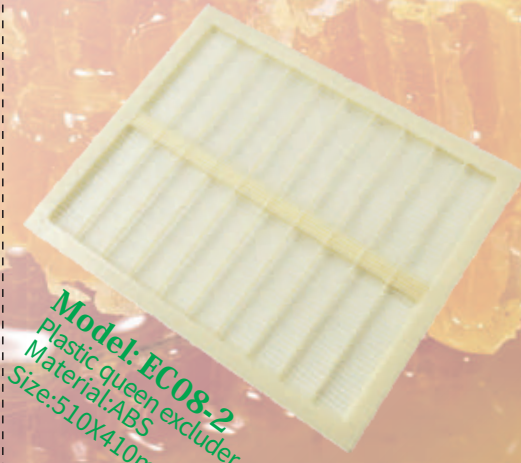

Model: EC08-2
Plastic queen excluder
Material: ABS
Size: 510X410mm

CTN: 40PCS



Queen excluders

Benefitbee®

The material or colors can be customized as per customer's request

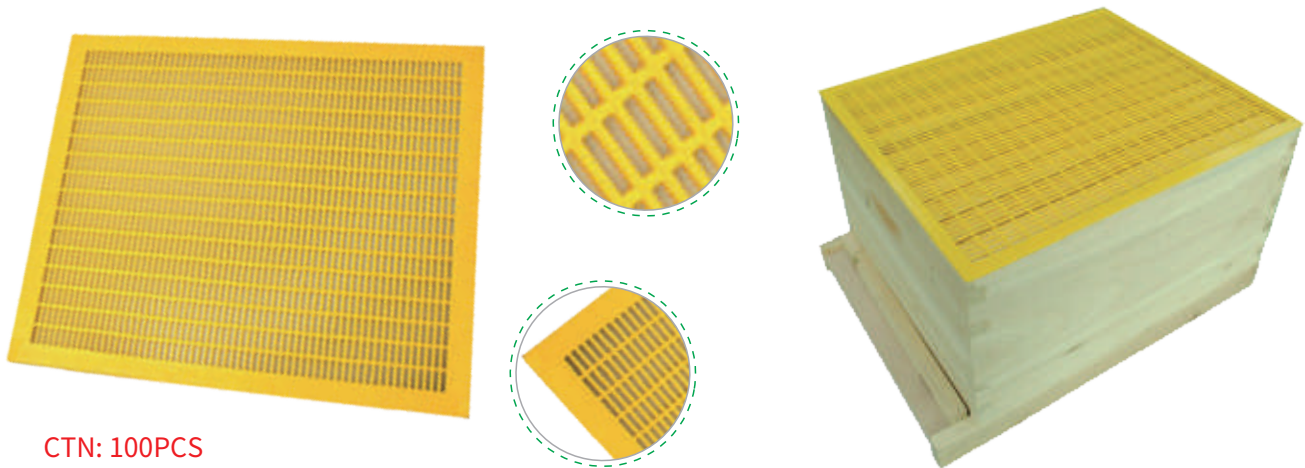

CTN: 100PCS

Model: EC05 Plastic queen excluder (color can be customized)

Available specifications:

510X410mm 500X500mm 510X425mm 500X450mm
510X360mm 460X460mm 485X400mm 505X360mm
506X406mm 510X420mm 435X435mm 506X360mm
506X353mm 500X425mm 470X410mm 500X430mm

Serves as a selective barrier inside the hive, limiting where the queen and drones can travel.

- *Allows bees to pass through more readily.
- *Precise spacing and no rough edges to harm your bees.
- *Excellent plastic quality.
- *Easy to clean and corrosion proof.
- *Many sizes available.



CTN: 50PCS

Model: EC06

Plastic queen excluder (color can be customized)

Available specifications:

510*410mm/460*460mm/435*435mm/
506*406mm/506*353mm/500*500mm/470*410mm

◆ Alternate permutation Not hurting bees



Queen excluders

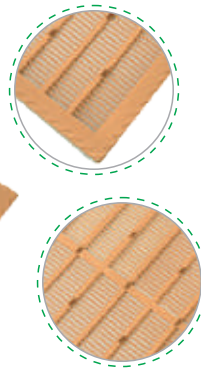

CTN: 50PCS
Material:PP

Model: EC09-1 Propolis collector

Available specifications:

410X510mm	420X510mm	435X435mm	460X460mm
470X410mm	470X470mm	485X478mm	485X400mm
500X425mm	500X430mm	500X500mm	500X450mm
505X360mm	506X353mm	506X406mm	510X425mm
510X360mm			



CTN: 45PCS
Material:PP

Model: EC09-2

New Zealand style Propolis collector

Available specifications:

500X400mm

Collect more propolis than regular 4mm mesh mats, easy to clean up

surface painted
Size: customizable

Model: EC12

Painting metal queen excluder

Wire diameter: 1.9mm

Gap: 4.2mm

size: customizable, surface painted



Pollen traps



- Can be hooked on hive
- Pollen trap can be pulled and pushed



Model: PT02

Pollen trap

Weight: 507g

Size: 305X105X145mm

CTN: 20PCS



- High quality plastic material



PT01
Pollen trap

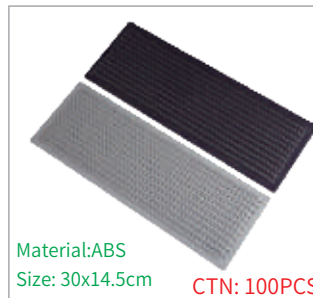

PT07
Pollen trap

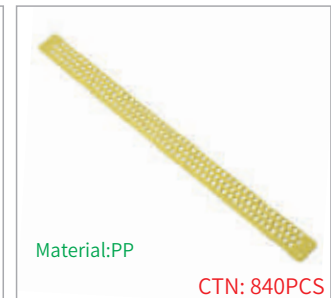

PT04
Pollen trap



PT08
Pollen trap

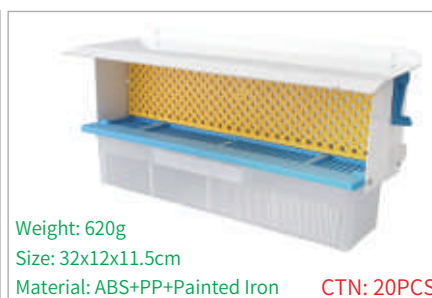

PT09
Pollen trap



PT10
Frame gripper



Bee feeders



Model: FD13/FD13B

BB Top feeder (Australia style 3.5L/2.5L)

Size: 505*405mm/506*353mm CTN: 20PCS

Appearance Patent No.: 201930629685.X

Utility Model Patent No.: 201921966873.2

Model: FD13-2

BB Top feeder (US style 4.5L)

Size: 505X405mm CTN: 10PCS

Appearance Patent No.: 201930629684.5

Utility Model Patent No.: 201921966873.2

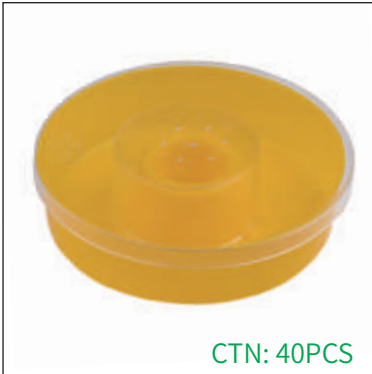

CTN: 40PCS

FD08-3

Top feeder (1.3L)
Size: 210X55mm

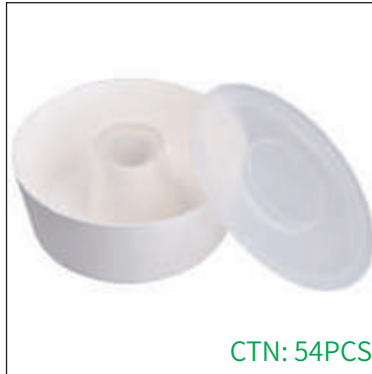

CTN: 54PCS

FD08-4

Top feeder (1.7L)
Size: 217X85mm



CTN: 50PCS

FD08

PP Top feeder (1.3L)
Size: 260X55mm

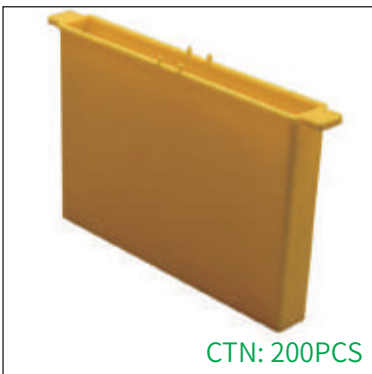

CTN: 200PCS

FD19

Division feeder (0.5L)
Size: 25X3.3X15cm

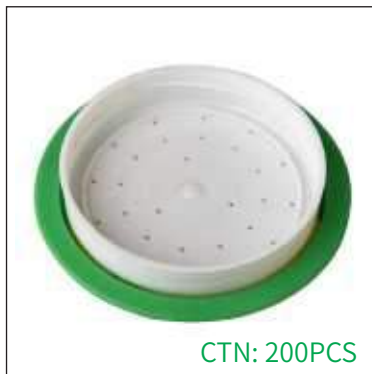

CTN: 200PCS

FD21

Boardman feeder
Diameter: 75mm

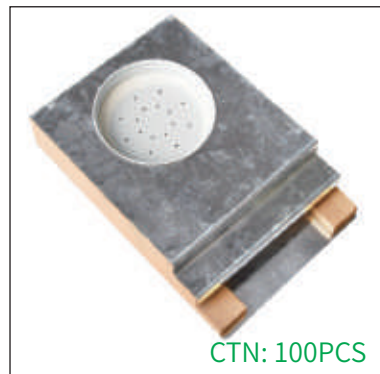

CTN: 100PCS

FD22

Boardman feeder
(Pine + Galvanized Iron)
Size: 170X113X35mm



Bee feeders



CTN: 30PCS



• **FD02-2 (4L)**
Size:483*55*220mm
Weight:620g

• **FD02 (6L)**
Size:483*80*230mm
Weight:850g

• **FD01 (6L)**
Size:483*80*230mm
Weight:850g

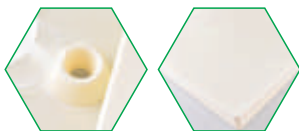

Model: FD07
390X370X70mm
Capacity: 6L
CNT:10PCS

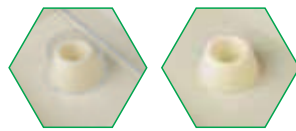

Model: FD07B
390x330x75mm
Capacity: 6L
CNT:10PCS

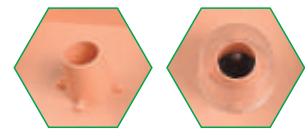

Model: FD18
180X180x55mm
Capacity: 1.6L
CNT:60PCS



FD02-3

Size:233X120X25mm
Capacity: 0.5L
CNT:50PCS



FD06

Size:483X35X240mm
Capacity: 4L
CNT:12PCS

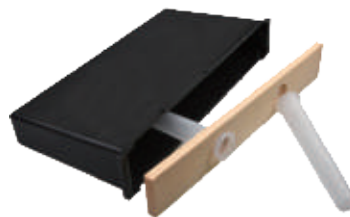

FD01W

Size:483X80X230mm
Capacity: 6L
CNT:25PCS



FD14

Size:483X80X230mm
Weight: 340g
CNT:20PCS



Bee feeders



Model: FD11
(1.5L)
Material:PP+ABS
CTN: 50PCS



Model: FD15
(1 L)
Material:PP
CTN: 100PCS



Model: FD17
(0.5L)
Material:PP
CTN: 150PCS

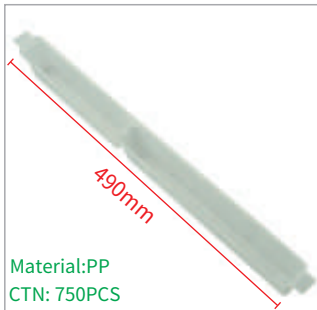

FD03 (0.75L)

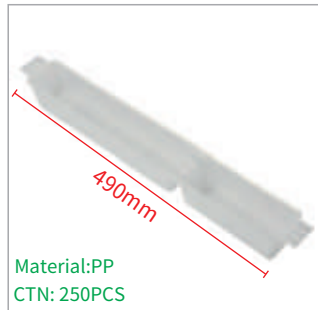

FD03-2 (1.5L)



FD03-3 (3L)

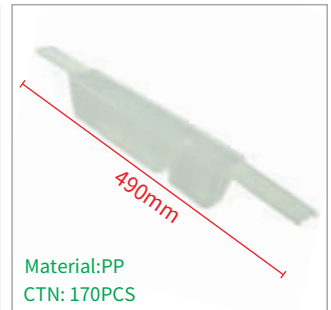

FD03-4 (1L)



FD03-5 (0.6L)



FD03-6 (1.6L)



FD04 (0.5L)



FD05

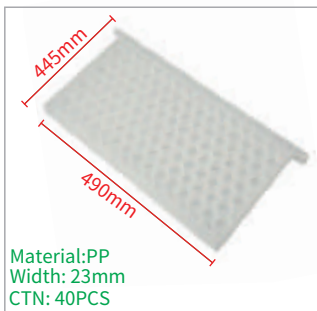

FD09



FD10



FD12



FD16



Bee smokers

Benefitbee®

OEM/ODM available >>

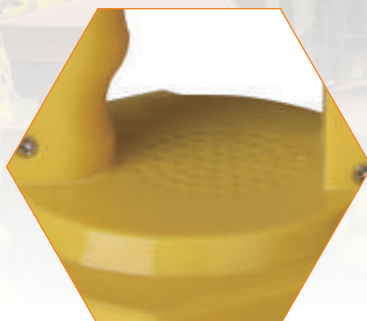

Patented product

Patent No.: 202030576923.8

Model	S12
Size	13.7*29*27cm
Material	PC+SUS201
CTN	20PCS





Bee smokers

Benefitbee®

OEM/ODM available >>

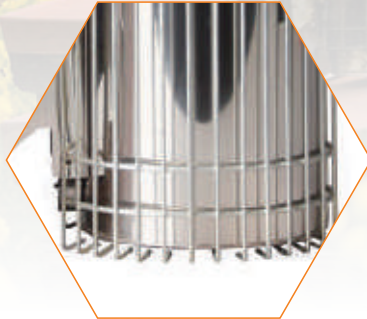

● Eco-friendly degradable leather

● Polished surface treatment

● High quality big spring inside

● Durable hinge

● Aluminum nails in the rim

● Finger-protection heat shield

Model: S01

● Air inlet

● Heat insulation bottom

Model	S01-L	S01
Size	L Φ :10cm h:30cm	M Φ :10cm h:26cm
Material	SUS201	
CTN	20PCS	





Bee smokers

Benefitbee®

OEM/ODM available >>

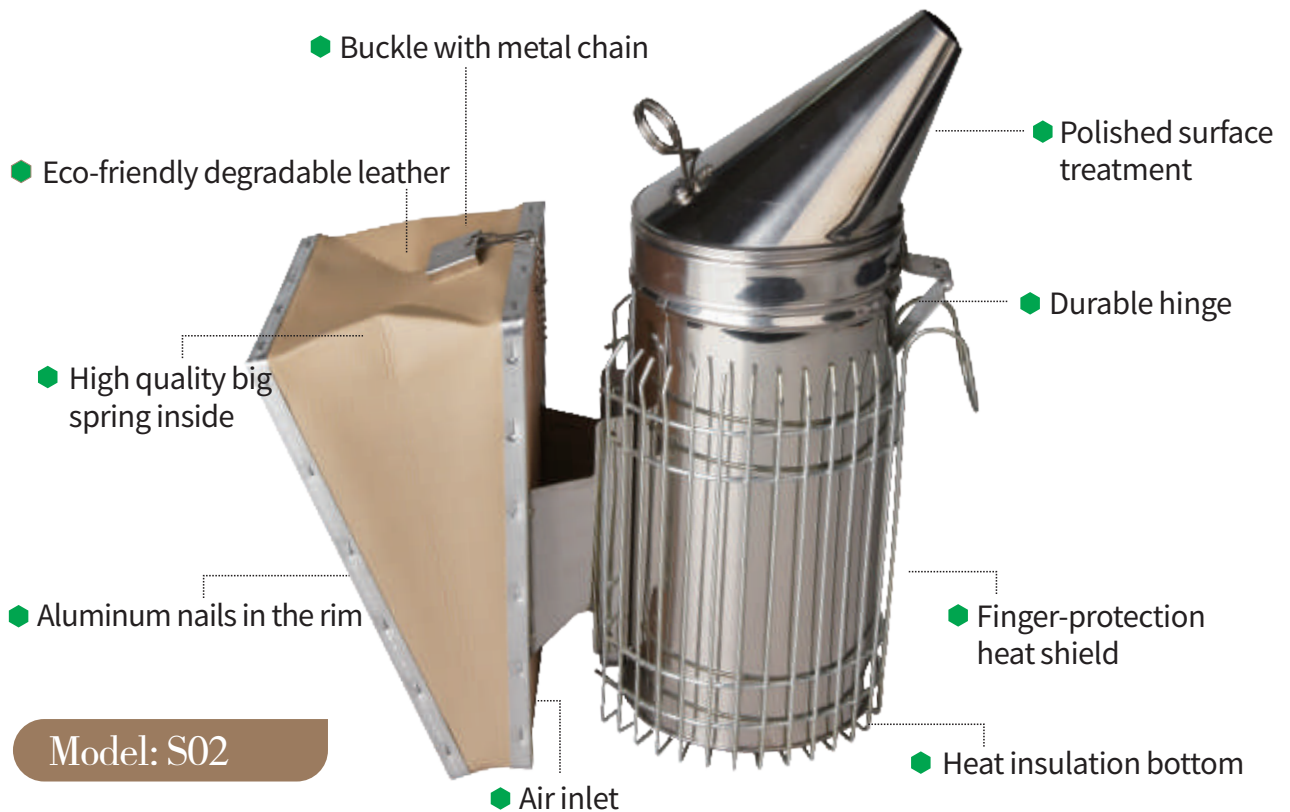

Model: S02

Model	S02-L	S02
Size	L Φ :10cm h:32cm	M Φ :10cm h:29cm
Material	SUS201	
CTN	20PCS	





Bee smokers

Benefitbee®

OEM/ODM available >>



Model	S03
Size	Φ:10cm h:29cm
Material	SUS201
CTN	20PCS

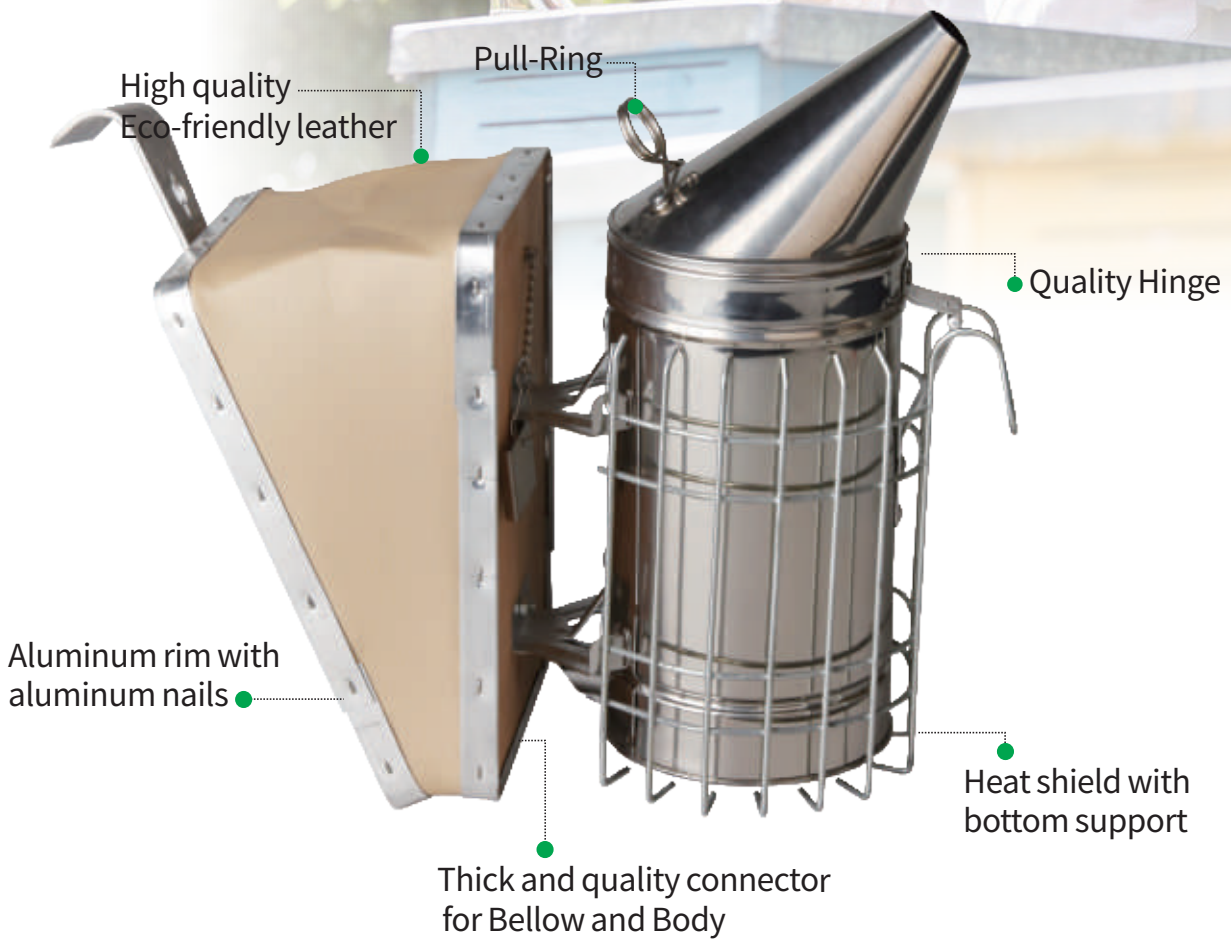



Bee smokers

OEM/ODM available >>

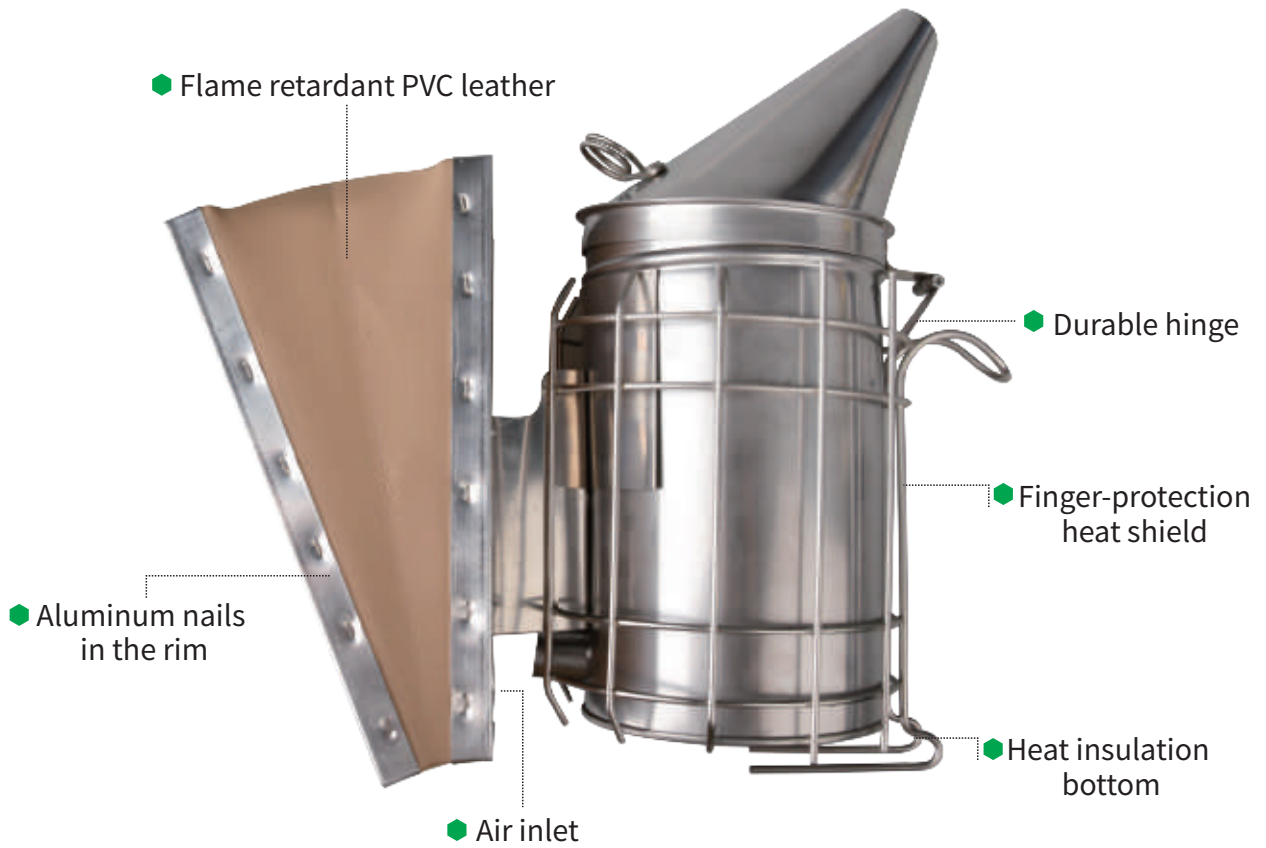

Model	S13-L	S13
Size	L Φ :10.5cm h:34cm	M Φ :10.5cm h:28cm
Material	SUS201	
CTN	20PCS	





Bee smokers



OEM/ODM available >>



Model	S04-L	S04
Size	L Φ :10cm h:32cm	M Φ :10cm h:29cm
Material	SUS201	
CTN	20PCS	



Model	S05-L	S05	S05-S
Size	L Φ :10cm h:29cm	M Φ :10cm h:24cm	S Φ :8.5cm h:21cm
Material	SUS201		
CTN	10PCS	15PCS	15PCS



Model	S06-L	S06	S06-S
Size	L Φ :10cm h:31cm	M Φ :10cm h:28cm	S Φ :8.5cm h:26cm
Material	SUS201		
CTN	10PCS	15PCS	15PCS



Model	S07-L	S07	S07-S
Size	L Φ :10cm h:31cm	M Φ :10cm h:28cm	S Φ :8.5cm h:26cm
Material	Galvanized		
CTN	10PCS	15PCS	15PCS



Bee smokers

Benefitbee®

OEM/ODM available >>

Model : SP06

Smoker box

(This product does not include smoker)

Material: iron chrome plated

201 stainless

Product size: 24.5x15.4x37.5cm

CTN: 10PCS

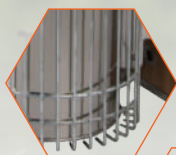

Can be equipped with inner tank



CTN: 20PCS

Size:20cm*Φ7.5cm

Model : S05-BS

Smoker(Economic XS)

Material:SUS201



CTN: 18PCS

Size:26cm*Φ10cm

Model : S17

Smoker(Italian style L/M/S)

Material:SUS201



CTN: 20PCS

Φ:10cm
H:24cm
W:21cm

Model : S15

Smoker(European style)



CTN: 3PCS

Φ:15cm
H:43cm
W:25cm

Model : S14

Smoker(South America)



CTN: 5PCS

Φ:10cm
H:24cm
W:21cm

Model : S16

Smoker(European style electric)



Bee smokers

Benefitbee®

OEM/ODM available >>



Model: S11

CTN: 4PCS

l:33cm
w:13cm
h:40cm



Model: S11-2

CTN: 4PCS

L:33cm
W:13cm
H:40cm



Model: S10

CTN: 15PCS

Φ:8.5cm
h:26cm



Model: S08

CTN: 40PCS

Φ:6.5cm
h:18cm



Model: S09

CTN: 10PCS

Φ:10cm
h:28cm



Model: S09-2

CTN: 15PCS

Φ:10cm
h:26cm



Bee smokers

Benefitbee®

OEM/ODM available >>

Cow leather



SP01

CTN: 100PCS

Micro leather



SP01-2

CTN: 60PCS

PU



SP01-3

CTN: 60PCS

Plastic



SP02

CTN: 60PCS

Stainless steel



SP04

CTN: 500PCS

Smoker fuel



SP05

CTN: 100PCS



SP03

CTN: 100PCS



SP03-S

CTN: 100PCS



SP05-2

CTN: 200PCS



Honey extractors



OEM/ODM available >>



HE01

2 frames plastic manual honey extractor
CTN: 1PCS



HE03-2

Economy 2 frames manual honey extractor
CTN: 1PCS



HE04-2

Economy 2 frames manual honey extractor
CTN: 1PCS



HE02-2

2 frames full transparent manual honey extractor
CTN: 1PCS



HE02-3

3 frames full transparent manual honey extractor
CTN: 1PCS



HE05-2

2 frames manual self reversal honey extractor
CTN: 1PCS



HE05-3

3 frames manual self reversal honey extractor
CTN: 1PCS



HE05-4

4 frames manual self reversal honey extractor
CTN: 1PCS





Honey extractors



OEM/ODM available >>



Model:HE06-2
2 frames manual
honey extractor
CTN: 1PCS

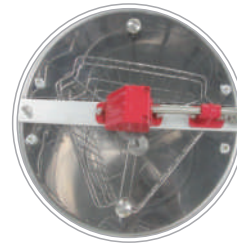

Model:HE06-3
3 frames manual
honey extractor
CTN: 1PCS

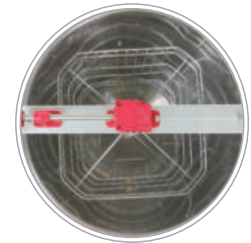

Model:HE06-4
4 frames manual
honey extractor
CTN: 1PCS



Model:HE06-2E
2 frames electric
honey extractor
CTN: 1PCS

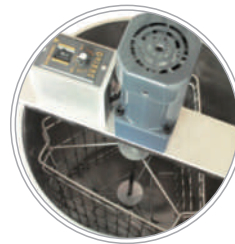

Model:HE06-3E
3 frames electric
honey extractor
CTN: 1PCS



Model:HE06-4E
4 frames electric
honey extractor with
CTN: 1PCS



Model:HE06-6
6 frames manual
honey extractor
CTN: 1PCS



Model:HE06-8
8 frames manual
honey extractor
CTN: 1PCS



Honey extractors



OEM/ODM available >>

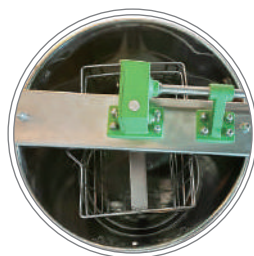

Model : HE12-2
Extractor
(2 frames manual brake)
CTN: 1PCS

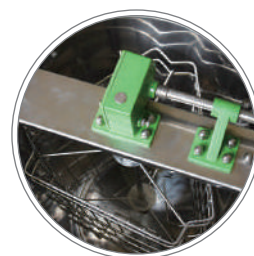

Model : HE12-3
Extractor
(3 frames manual brake)
CTN: 1PCS



Model : HE12-4
Extractor
(4 frames manual brake)

Barrel height: 60CM
Diameter: 48CM
Total height: 110cm
Inner frame material : sus304
Barrel body material : sus201
Rack:45X26cm
CTN: 1PCS



HEPJ01/-2/HEPJ03

2/3/4/6/8 frame manual gear assembly
4 frames have other specifications



HEPJ02/-2/HEPJ04

2/3/4/6/8 frame manual gear assembly + beam



HEPJ16

Handle



Honey extractors



OEM/ODM available >>



Model:HE06-6E
6 frames electric
honey extractor
CTN: 1PCS

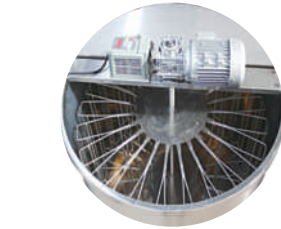

**Model:HE06-8E/HE06-12E
HE06-20E/HE06-24E**
8/12/20/24 frames
electric Honey extractor
CTN: 1PCS

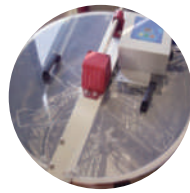

Model:HE06-6EM
6 frames electric honey
extractor (Three use)
CTN: 1PCS



Model:HE07-4
4 frames electric
honey extractor
CTN: 1PCS



Model:HE08-2
2 frames manual self reversal honey extractor
(Gear box with brake function, steering handle)
CTN: 1PCS

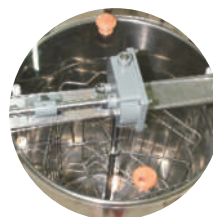

Model:HE08-3
3 frames manual self reversal honey extractor
(Gear box with brake function, steering handle)
CTN: 1PCS



Model:HE08-4
4 frames manual self reversal honey extractor
(Gear box with brake function, steering handle)
CTN: 1PCS



Hive tools



OEM/ODM available >>



Model: T15 Multifunctional hive tool

China Patent: ZL201520103196.7 ZL201530043392.5

High-quality stainless steel, sturdier wood, exquisite workmanship, powerful beekeeping hive tool, that incorporates up to a half dozen applications iron tool: Hive scraper, frame cleaner, nail puller, queen excluder straightener and cleaner, pry bar, detachable hammer, etc. It will last a lifetime! A must have for all beekeepers.

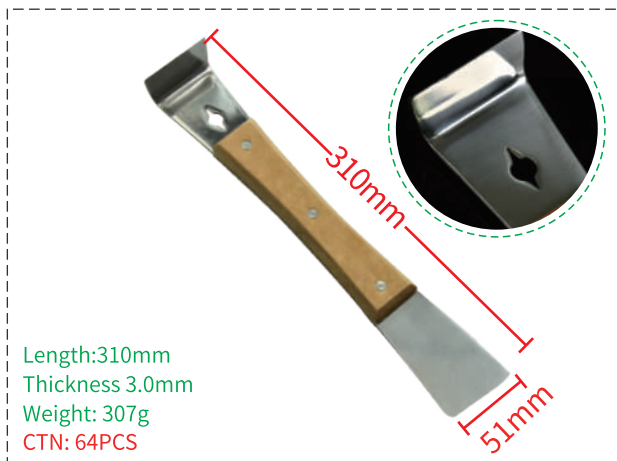

Length: 310mm
Thickness: 3.0mm
Weight: 307g
CTN: 64PCS

T02-L



Material: 2CR13
Mirror splishing & Spray paint
CTN: 80PCS

T14

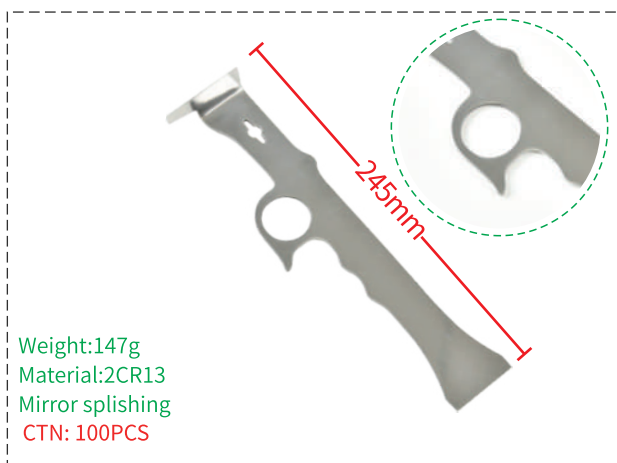

Weight: 147g
Material: 2CR13
Mirror splishing
CTN: 100PCS

T24

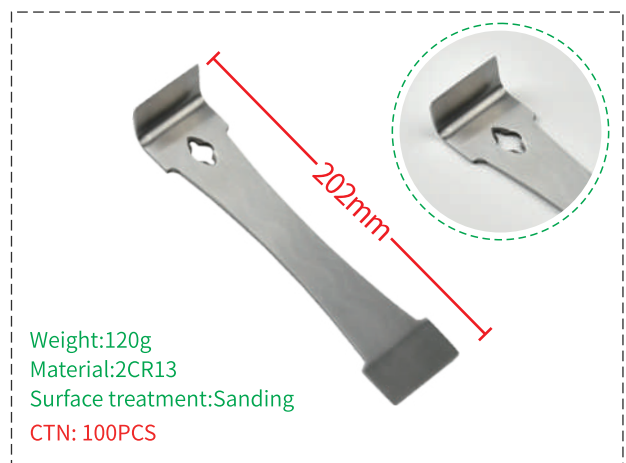

Weight: 120g
Material: 2CR13
Surface treatment: Sanding
CTN: 100PCS

T19



Hive tools



OEM/ODM available >>

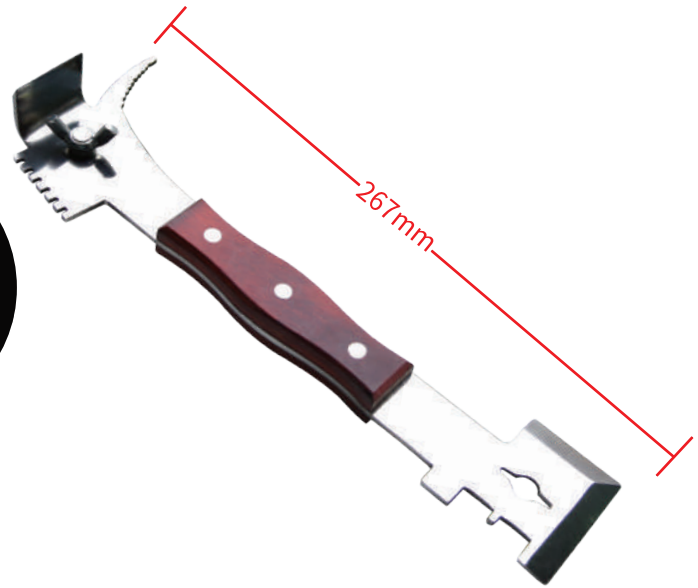

Model: T15B

BB Multifunction hive tool(Patent)

Surface treatment: mirror luster logwood handle

Weight: 300g

Material: 2CR13

CTN: 64PCS



Material :2CR13
Thickness :2.6-2.7mm
Surface treatment: mirror light
CTN: 60PCS

T01-C

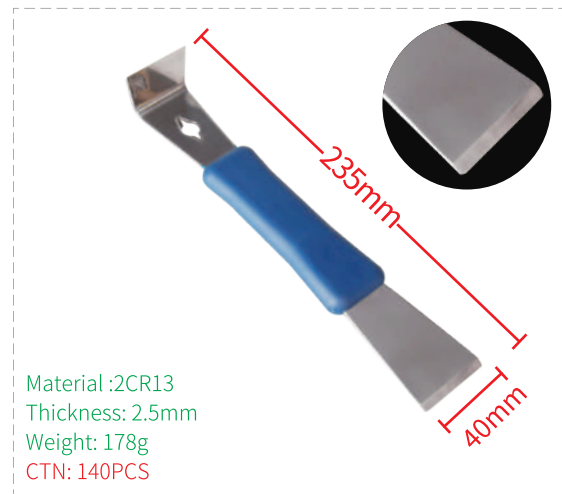

Material :2CR13
Thickness: 2.5mm
Weight: 178g
CTN: 140PCS

T01-P



Material:2CR13
Thickness:2.5mm
Weight:145g
CTN: 100PCS

T01-SP



Weight:130g
Shovel:45mm
Material:2CR13
Thickness:2.5mm
CTN: 100PCS

T04-TP



Material: 430 Spring steels
Hardness: 40,
Single weight: 197g,
Surface technology: spray paint
CTN: 100PCS

T30







Hive tools



OEM/ODM available >>



Model: OT01
Multi-function claw hammer





 <p>2CR13 260mm</p> <p>Weight:120g CTN: 100PCS</p>	 <p>2CR13 310mm</p> <p>Weight:115g Mirror splishing CTN: 120PCS</p>	 <p>2CR13 Sanding 250mm</p> <p>Thickness:3.0mm Weight:154g CTN: 100PCS</p>	 <p>2CR13 Sanding 330mm</p> <p>Thickness 3.0mm Weight:203g CTN: 80PCS</p>
--	---	---	---

T23

T25

T28

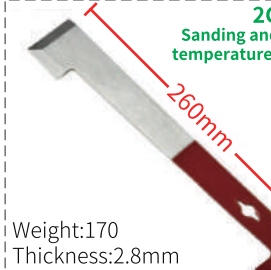
T29





 <p>2CR13 Sanding and high temperature paint 240mm</p> <p>Weight:145g Thickness:2.5mm CTN: 100PCS</p>	 <p>2CR13 Sanding and high temperature paint 260mm</p> <p>Weight:170g Thickness:2.8mm CTN: 100PCS</p>	 <p>2CR13 Sanding and high temperature paint 260mm</p> <p>Weight:170 Thickness:2.8mm CTN: 100PCS</p>	 <p>2CR13 & Wooden handle Sanding 190mm</p> <p>Weight:90g CTN: 160PCS</p>
---	---	---	---

T01-S

T01-2

T04

T17



 <p>2CR13 Mirror splishing 310mm</p> <p>Weight:65g CTN: 320PCS</p>	 <p>2CR13 Splishing 260mm</p> <p>Weight:164g Thickness:2.8mm CTN: 100PCS</p>	 <p>2CR13 Splishing 285mm</p> <p>Weight:164g Thickness:2.8mm CTN: 100PCS</p>	 <p>Galvanized steel structure 218mm</p> <p>Weight: 125g CTN: 200PCS</p>
--	--	---	--

T20

T01

T16

T21

 <p>2CR13 220mm</p> <p>Thickness:2.4mm Weight: 112g CTN: 320PCS</p>	 <p>SUS430 Mirror polish</p> <p>CTN: 200PCS</p>	 <p>2CR13 Sanding 285mm</p> <p>Weight:125 Thickness:2.8mm CTN: 100PCS</p>	 <p>2CR13 Sanding and high temperature paint 260mm</p> <p>Weight:170g Thickness:2.8mm CTN: 100PCS</p>
---	---	--	---

T22

T27

T03-T

T01-3



OEM/ODM available >>

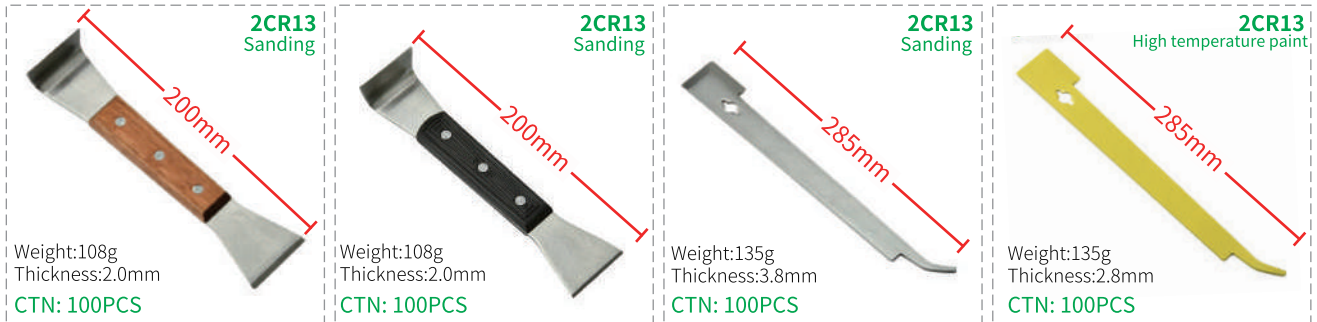

T02

T02-P

T03

T03-2



T04-T

T05

T06

T07



T08

T26

T09

T01-R

T10



T11

T12

T13

T17-2

T18



Uncapping knives



OEM/ODM available >>



Model: K10-Y

#304 Stainless Steel

Switch control: Long press to turn on or off, short press to switch Celsius and Fahrenheit Plus or Minus 5 unit each by pressing "+" or "-" button

Adjustable temperature: 0-180°C

Voltage:110-220V Power:300W

CTN: 25PCS

Patent No.:202030295900.X

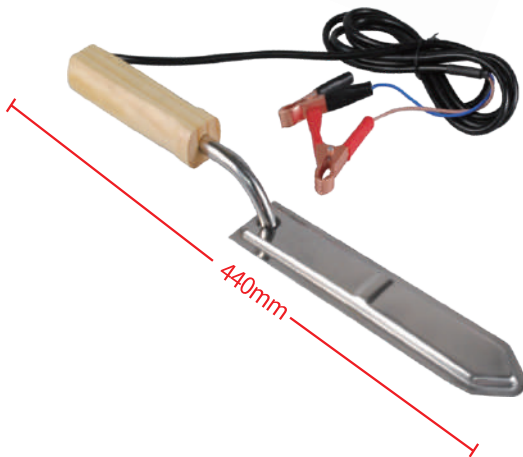
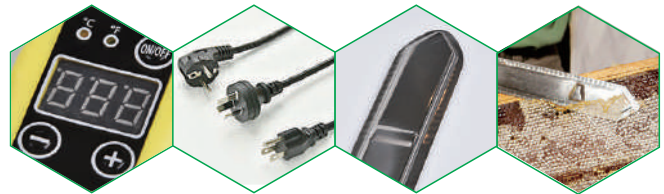

Model: K10-E

#304 Stainless Steel

Electric heated uncapping uncaps honeycomb in a few simple swipes.

Temperature: 150-190°C

Voltage: 12V Power: 300W

CTN: 25PCS

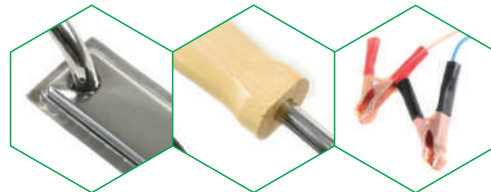

Model: K10-T



CTN: 25PCS

#304 Stainless Steel

Electric uncapping knife with thermo regulator CE certificate. Slides right along the outer edges of the frame and makes a nice cut. ON-OFF switch attached to control temperature, avoid over-heating.

Voltage:110&220V Optional Power:300W

Model: K10



CTN: 25PCS

#304 Stainless Steel CE certificate

Designed for easy uncapping to extract honey faster. No more messy chunks of wax in all over the place

Temperature: 150-190°C

Voltage:110-220V Power:300W



Uncapping knives



OEM/ODM available >>



Model:K10-TS



Model: K16



Model: K21



Model: K10-B



K11-2
Weight:120g
CTN: 266PCS
Patent No.:201530031130.7



K07
Weight:126g
Thickness:1.2mm
CTN: 266PCS



K08
Weight:107g
Thickness:1.0mm
CTN: 250PCS



K09
Thickness:0.6mm
CTN: 300PCS



K11
Thickness:1.2mm
CTN: 140PCS



K12
Weight:231g
CTN: 150PCS



K06
Weight:190-210g
CTN: 60PCS



K18
Weight:202g
CTN: 80PCS



K13-S
Weight:57g
Thickness:1mm
CTN: 80PCS



K03-L
Weight:76g
Thickness:1mm
CTN: 200PCS



K14
CTN: 480PCS



Uncapping knives



OEM/ODM available >>





Uncapping forks



OEM/ODM available >>

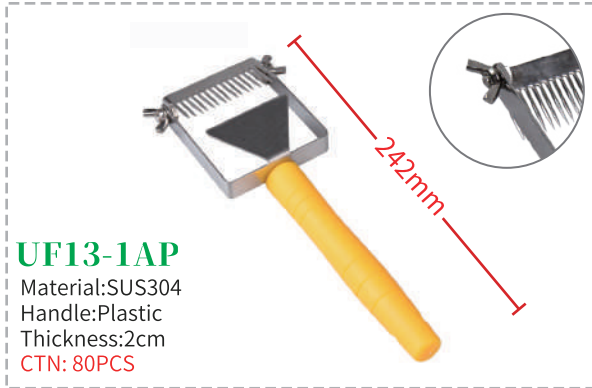

UF13-1AP

Material:SUS304
Handle:Plastic
Thickness:2cm
CTN: 80PCS



UF13-3AP

Material:SUS304
Handle:Plastic
CTN: 80PCS



UF13-1P

Material:SUS304
Handle:Plastic
Thickness:2cm
CTN: 80PCS



UF13-3P

Material:SUS304
Handle:Plastic
CTN: 80PCS



UF13-1A

Material:SUS304
Handle:eucalyptus
CTN: 80PCS



UF13-2A

Material:SUS304
Handle:wooden handle
CTN: 60PCS



UF13-3A

Material:SUS304
Handle:wooden handle
CTN: 80PCS



UF13-1

Material:SUS304
Handle:eucalyptus
CTN: 80PCS



UF13-2

Material:SUS304
Handle:wooden handle
CTN: 80PCS



UF13-3

Material:SUS304
Handle:wooden handle
CTN: 80PCS



UF13-4

CTN: 80PCS



Uncapping forks



OEM/ODM available >>

Roller length:100/150/ 200/250mm
CTN: 100PCS

Weight:265g
Material:pp
CTN: 24PCS

Thickness:0.21cm
Weight: 150g
Materail:SUS304 +PP
CTN: 100PCS

UF14

UF06

UF12

Uncapping fork (17 needles)
CTN: 400PCS

CTN: 48PCS

Needle thick:1.6mm
Handle material:Aluminum&wooden
CTN: 100PCS

Honey Uncapper
CTN: 1PCS

UF15

UF04

UF03

UF16

Needle thickness:2.0mm
Color: red, yellow, green
Needle: straight/ curved
CTN: 300PCS

Needle thickness:1.6mm
Color: red, yellow, green
Needle: straight/curved
CTN: 400PCS

CTN: 180PCS

Weight:240g
Handle: CTN:51*34*35.5cm 200PCS/CTN GW:31.95kg
Wheel: CTN:59*45*42cm 273PCS/CTN GW:25.3kg

UF01

UF02

UF11

UF05-2

Weight:220g
Handle: 150PCS/CTN GW:21.5kg
Wheel: CTN:59*45*42cm 273PCS/CTN GW:25.3kg

Colour:Yellow
CTN: 200PCS

Weight:85g
Needle thickness:1.6mm
CTN: 150PCS

CTN: 150PCS

UF05

UF07

UF08

UF09



Frame grip tools



OEM/ODM available >>

Model: FG18

BB Frame grip
Product material: 201SUS

Patented product

Patent N o.: ZL 2022 3 0265800.1



FG01
Material:SUS2CR13
CTN:100PCS

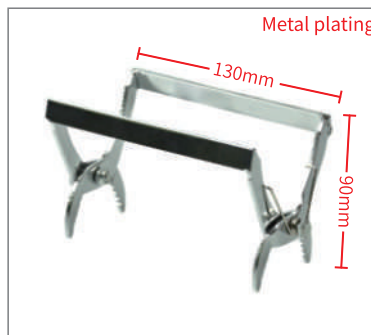

FG02
Material:Iron
CTN:100PCS



FG03
Material:2CR13
CTN:48PCS



FG04
Material:Galvanized iron
CTN:64PCS



FG05
Material:Galvanized iron
CTN:64PCS

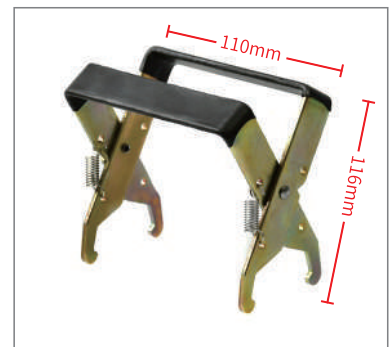

FG06
Material:Galvanized iron
CTN:60PCS



FG07
Material:SUS201+Beech wood
CTN:60PCS



FG10
Material:Galvanized iron
CTN:64PCS



FG11
Material:Galvanized iron
CTN:50PCS



FG12
Material:Aluminum
CTN:50PCS



Frame grip tools

OEM/ODM available >>



FG14
Material:SUS201
CTN:160PCS



The frame holder range: width:25--30mm
Thickness ≤22 mm

FG15
The lithium battery : 2000mAH
CTN:5PCS



Clamping range: width 25-30mm
Thickness ≤22mm

FG15-2
Battery capacity: 2000 mAh
CTN:5PCS



FG09
Material:SUS201
CTN:40PCS

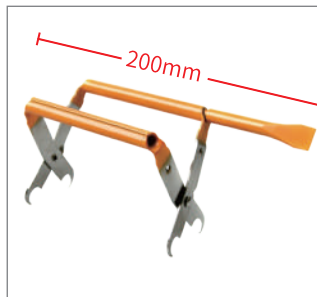

FG08
Material:SUS201
CTN:60PCS



FG08-2
Material: ABS+
Stainless steel ring
CTN:20PCS



FG13
Material:2CR13
CTN:40PCS



FG16
Material: stainless steel
CTN:64PCS



FG17
Material:SUS201
CTN:50PCS



FG17-2
Material:SUS201
CTN:40PCS

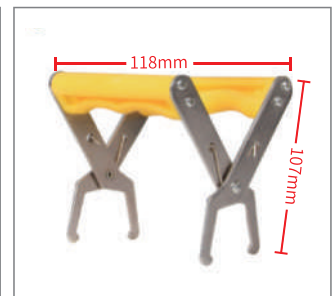

FG07-2
Material:SUS201+PP
CTN:50PCS



Filter tools



CTN:10PCS
Diameter:Φ320mm
Mesh material:SUS304
Filter screen height:65mm
Upper layer:16 mesh
Under layer:40 mesh

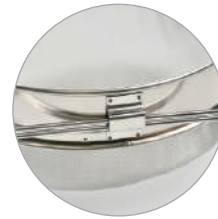

Model: FT01B(Φ32cm)

304 STAINLESS STEEL is durable, highly resistant to rust and oxidation. Designed with two separate screens: the upper sieve removes large debris, while the lower sieve strains out fine particles. Adjustable brackets to fit dia 21-40cm bucket size, strain honey faster and easier. Easy to clean with warm soapy water and dry immediately.



Model: FT01-3

Double strainer (Φ24cm)
Material: SUS304 & SUS201
Diameter: 24cm, Height: 15.3cm
CTN:10PCS



Model: FT11

Double honey strainer
Mesh material:SUS304
CTN:10PCS



FT07-3
CTN:200PCS



Mesh material:SUS304
Upper layer:16 mesh, Under layer:40 mesh

FT01
CTN:10PCS



Mesh material:SUS304,
Upper layer:16 mesh, Under layer:40 mesh

FT01-2
CTN:10PCS



Material:SUS201

FT05
CTN:50PCS



Material:SUS201

FT05-2
CTN:50PCS



Material:SUS201 Under layer:40 mesh

FT06
CTN:50PCS



OEM/ODM available >>



Modle: FT13

Honey comb holder uncapping tray

Size:stainless steel disc: 600*400*95mm

Plastic box:

External dimension: 600x400x175mm

Internal dimension: 550*365*160mm

Mesh material:SUS201+PP

CTN:1 PCS

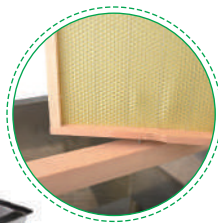
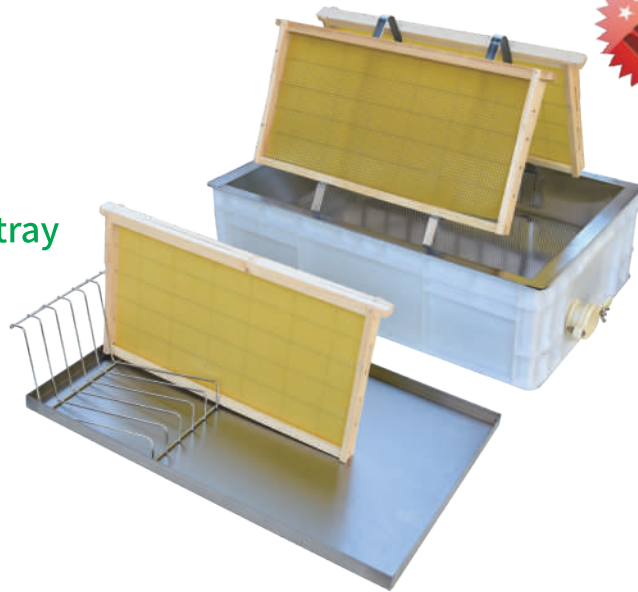

Modle: FT14

Uncapping tray

Plastic box:

External dimension: 600x400x230mm

Internal dimension: 550*365*220mm

Stainless steel disc: 600*400*150mm

Mesh material:SUS201+PP

CTN:1 PCS

Modle: FT15/FT16

Honey filter

Material:Nylon,201 Stainless steel ring

Product Size:

ø33cm ,1 mm square mesh,length 47cm.

ø33cm ,0.3mm square mesh,length 36cm.

ø33cm ,0.2 mm square mesh,length 36cm.

ø45cm ,1 mm square mesh length 47cm.

ø45cm ,0.3 mm square mesh length 36cm.

ø45cm ,0.2 mm square mesh length 36cm.

CTN:120/200/260 PCS





Filter tools



Model: FT04

Double honey strainer

Size:Φ230mm,Mesh material:ABS

CTN:10PCS



Model: FT03

Double honey strainer

Upper layer Size:Φ295mm

CTN:10PCS



Size:Φ240mm*60mm
Mesh material:Nylon
Case material:Nylon
Layer:26 mesh
CTN:20PCS

Model: FT02

Nylon double honey strainer



Material:SUS201
Surface Treatment:
Mirror polishing
CTN:1 PCS

Model: FT10

Uncapping tray

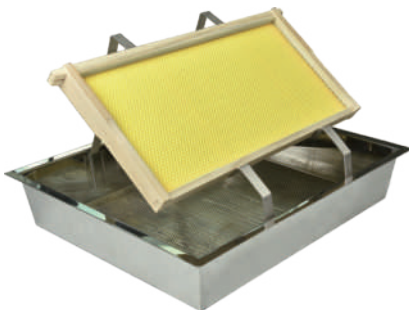

Surface Treatment: Sanding
Material:SUS201
Size: 470*432*100mm
CTN:1 PCS

Model: FT09

Uncapping tray



Model: FT09B

Plastic uncapping tub

Material:PP

CTN:3 PCS

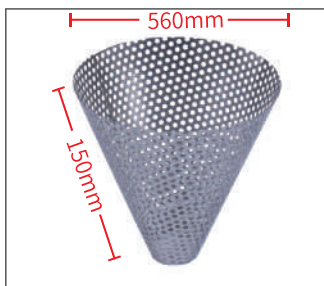

FT18

Honey filter
(304 stainless steel)
The hole spacing is 3.0mm

CTN:10 PCS



FT19/FT19-2

Stand for Strainer
Ø30cm/ Ø43cm
Material:SUS201
Weight: 1600g/1700g

CTN:10 PCS



FT08

Honey filter (Thin style)

Size:35X23cm
Material:Nylon

CTN:260 PCS



FT08-2

Honey filter
Size:50X35cm
Material:Nylon

CTN:240 PCS



Cleaning tools

Benefitbee®

OEM/ODM available >>



CL05
Material:SUS201
CTN:400PCS



CL06
Material:SUS201
CTN:200PCS

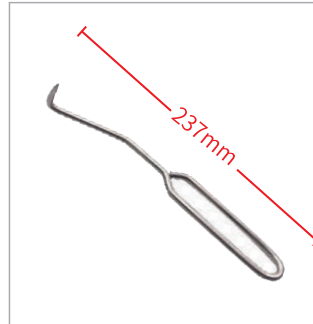

CL06-2
Material:SUS201
CTN:250PCS



CL07
Material:SUS304
CTN:1300PCS

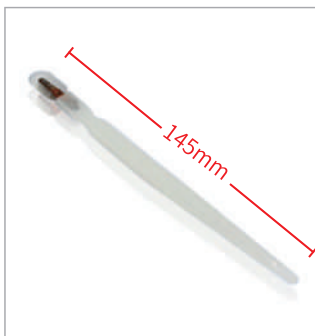

CL08
Material:PP
CTN:1500PCS

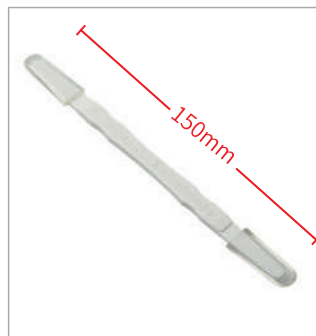

CL08-2
Material:Plastic
CTN:1500PCS



CL08-3
Material:Bamboo
CTN:1200PCS



CL08-4
Material:Plastic
CTN:100PCS

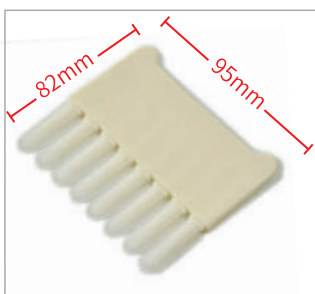

CL08-5
Material: PP/food grade
CTN:200PCS

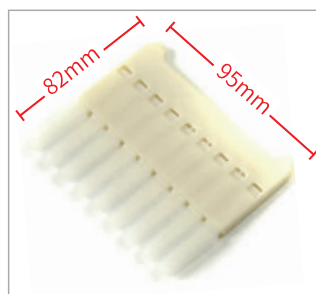

CL08-6
Material: PP/food grade
CTN:200PCS



CL09
Material: PP
CTN:100PCS

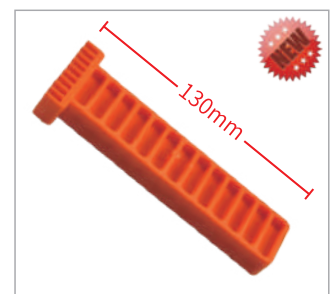

CL10
Material:PP
CTN:300PCS



Cleaning tools



OEM/ODM available >>



CL01
Material:Galvanized
CTN:180PCS



CL01-2
Material:SUS430
CTN:200PCS

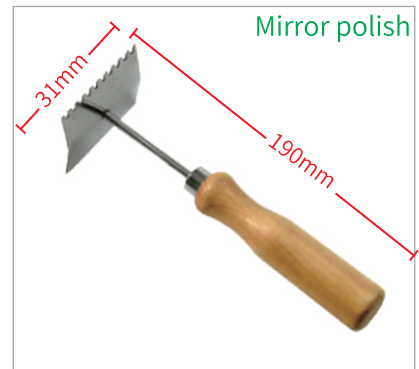

CL02
Material:SUS430
CTN:120PCS

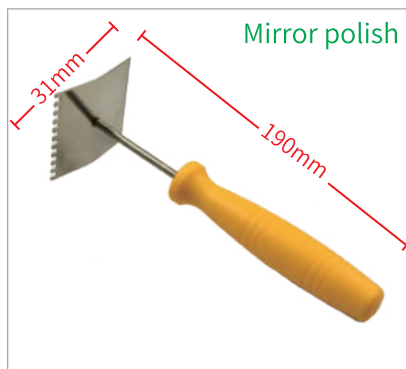

CL02-3
Material:PP & SUS430
CTN:120PCS



CL02-4
Material:Plastic
CTN:500 PCS

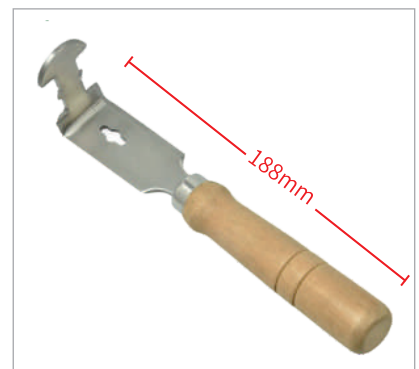

CL03
Material:Galvanized
CTN:200PCS

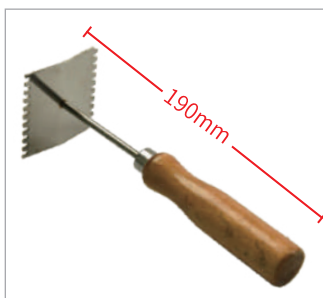

CL02-2
Material:SUS304
CTN:176PCS



CL09-2
Material: silicone spatula
CTN:100PCS



CL04
Material:SUS201
CTN:100PCS



CL09-3
Weight: 64g
CTN:250PCS



Bee brush

Benefitbee®

OEM/ODM available >>

Model:BR02

BB Bee brushes(Single row plastic)
Material: Plastic

CTN:100 PCS

◆ Patented product

Patent No.:201930551034. 3



Model: BR07

Bee brushes(single rows horsehair)
Material: Plastic&horsehair

CTN:600 PCS



Model: BR06

Bee brushes(Double rows horsehair)
Material: Pine&horsehair

CTN:500 PCS



Model: BR05

Bee brushes(Double rows bristles)
Material: Bristles&pine

CTN:500 PCS



Model: BR04

Bee brushes(Four rows horsehair)
Material: :Horsehair&pine

CTN:250 PCS



Bee brush



OEM/ODM available >>



CTN:1 PCS

Model: BR08

Electric bee taking-off machine
Rated power:150W,Voltage:12V



Handle:450mm
Brush width:7cm

Model : BR11

BB Bee brushes(Double rows bristles)

CTN:200 PCS



Model:RB01

Double rows horsehair bee brush
Material:Pine&Horsehair

CTN:150 PCS



Model:BR03

Single row plastic bee brush
Material: varnished beech + plastic brush

CTN:200 PCS



Model : BR09

Bee brushes(Three rows bristles)
Material:Bristles&Pine

CTN:320 PCS



Model : BR10

Bee brushes(Three rows plastic)
Material:Plastic&Pine

CTN:320 PCS



Bee gloves

Benefitbee®

Material,color,size,style can be customized



Model: BG07

Beekeeping glove

Material:White sheepskin +Polyester cotton

Size:L,XL,XXL

CTN:200PCS

Model: BG03

Beekeeping ventilated glove

Material:Golden sheepskin +

High breathable mesh+

Polyester cotton

Size:L,XL,XXL

Colour:yellow、 white

CTN:200PCS

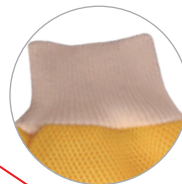

Model: BG11

Bee gloves(Euro Grade A sheepskin)

Material: Yellow sheepskin + TC breathable mesh

size :S-XXXL

CTN:200PCS



Bee gloves

Benefitbee®

Material,color,size,style can be customized

Model: BG08

Bee gloves (Euro,Grade A sheepskin)

Size:L,XL,XXL

Material:White sheepskin + Polyester cotton

CTN:200PCS



BG04

Size:L,XL,XXL



BG05

Size:L,XL,XXL



BG09

Size:L,XL,XXL



BG01PG

Size:L,XL,XXL



BG01CG

Size:L,XL,XXL



BG01CW

Size:L,XL,XXL



BG12

Size:S,M,L,XL,XXL

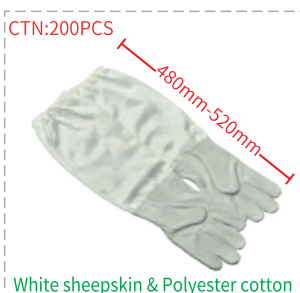

BG01PW

Size:L,XL,XXL



BG02

Size:L,XL,XXL



BG06

Size:L,XL,XXL



BG10

Size 39-45



Bee suits

Material,color,size,style can be customized



Model:BS16-2

Bee jacket

Material: 100% cotton

gr/m²: 150g

CTN:25PCS

Color :



Model:BS16

Bee jacket

Material: 100% cotton

gr/m²: 150g

Color:



Model:BS17

European style half-length round hat bee jacket (without zipper)

Model:BS19

European style bee pants

Color:

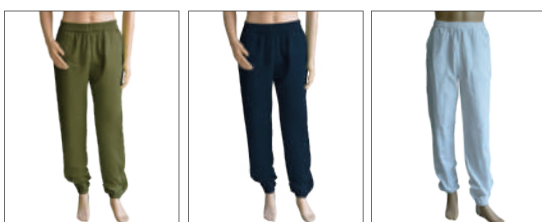



Bee suits

Benefitbee®

Material,color,size,style can be customized



Model:BS18

European astronaut hat overall beesuit

Material: 100% cotton



BS01-S



BS01



BS01-2



BS04



BS09



BS05



BS08



BS14



BS14-2



BS14-3



Bee suits



Material,color,size,style can be customized



BS06



BS07



BS10



BS11



BS12



BS09-2



BS13



BS15



BS16-3



Bee hats



Material,color,size,style can be customized

Model: BH06



Model: BH07



Model: BH02



BH01



BH01-2



BH09



BH04



BH04-2



BH05



BH08



BH03



BH10



BH11



Queen cages



Model: QC41

Wasp trap for plastic bottle



Model: QC49

Queen catcher



Model: QC51

Queen catcher



Model: QC44-2

JZB queen bee protection box



QC37-3
Queen control box
(2FRAME)



QC39
Queen catcher



QC42
Swarm catcher(Euro)



QC43
Marking cages



QC44
JZB queen bee protection box



QC45
Marking cages



QC50
Queen catcher



QC52
Queen catcher



Queen cages



Model: QC29

Wasp trap (Rotatable)



Model: QC32

Wasp trap (Large)



Model: QC31

Wasp trap (Solar LED light)



Model: QC30

Wasp trap (Gourd shaped)



QC35

Queen cages



QC36

Bee collecting cage



QC36-2

Bee collecting cage



QC37

Queen control box (1FRAME)



QC37-2

Queen control box (2FRAMES)



QC46

Skep straw hive(3PCS)



Queen cages



QC01



QC02



QC02-2



QC03



QC04



QC05



QC06



QC07



QC08



QC09

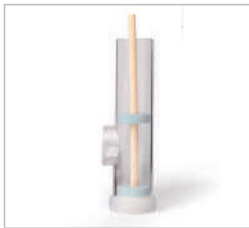

QC09-2



QC11



QC12



QC13



QC14



QC15



QC16



QC17



QC18



QC19



QC20



QC21



QC21-2



QC23



QC24



QC25



QC40



QC26



QC27



QC28



QC33



QC34



Model:QB43

BB Queen incubator
Input voltage: DC 12v
Heating temperature: 36 °C
Can put cell cup: 54pcs

Patented product

Patent No.: 202220476207.6

Model:QB01-9

Grafting tool
tip diameter:0.5mm
Weight:35g
Material:SUS420

Patented product

Patent No.:ZL 2022 3 0510174.8

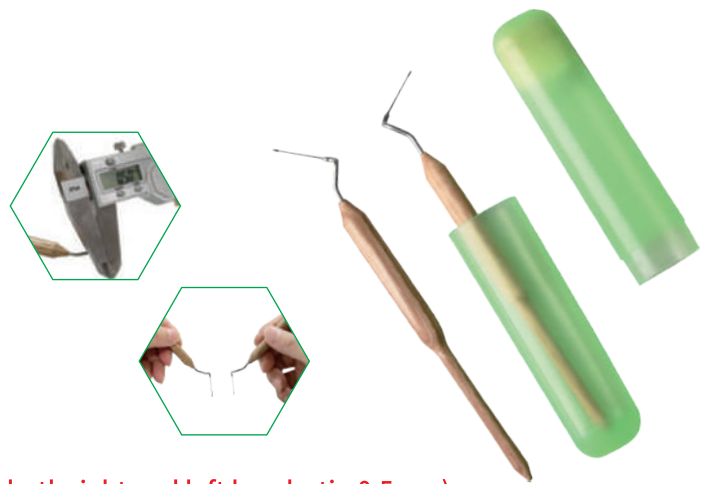

(fit for both right and left hands, tip 0.5mm)



QB01-8
Grafting tool



QB02-4
Head band magnifier
(not included battery)



QB04-7B
Queen cell bar

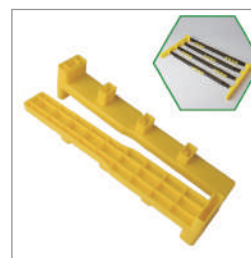

QB04-7C
JJBZ Plastic Royal
Jelly Frame



QB04-9
Holder for queen cell



QB04-12
Queen rearing box



QB38
Cell cup silicone
mould



QB38-2
Cell cup silicone
mould

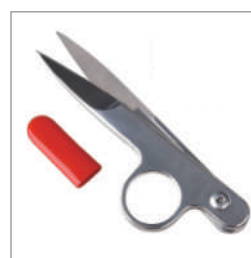

QB39
Scissor

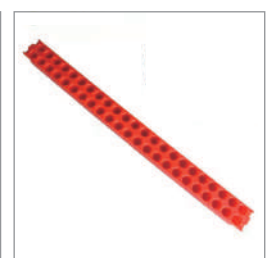

QB42
Queen shipper



Queen breed tools

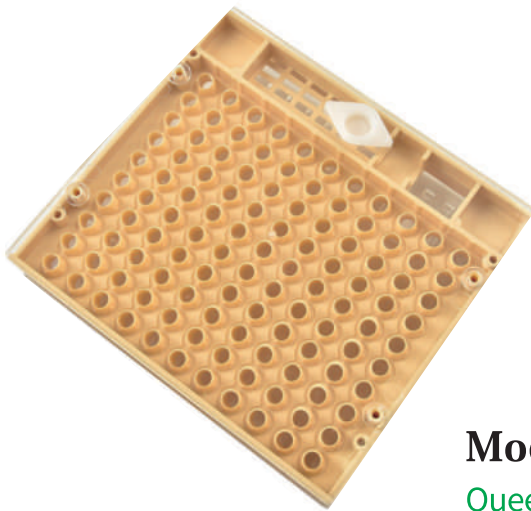

Model: QB04
Queen rearing box



Model: QB04-2
Queen cell

1. Insert the comb box into a frame and 110 brown cell starter cups are fitted into the back of it.
(With this kit you will be able to raise your own queens and do it without grafting or ever touching a larvae.)
2. Confine the queen in the front of cage and she immediately lays eggs in the 110 available cells.
She can be released in the next day. On the 4th day each newly hatched larvae is ready for transfer.
3. Remove each cell starter cup and insert it into a cell cup holder.
4. Slid this unit onto a cell bar holder which is attached to a cell bar.
5. To finish the cells you now put the cell bar into a cell building colony.

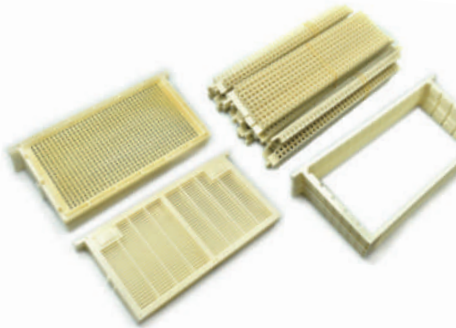

Model: QB06
No graft queen rearing system
for mellifera bees



Model: QB07
Queen marking pen



Model: QB08
Queen marking pen (1 PCS)



Model: QB06-2
Mellifera royal jelly frame

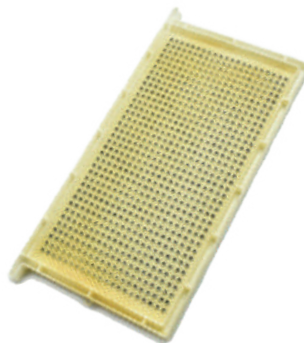

Model: QB06-3
Impregnated Mellifera larva
breeding frame



Model: QB06-5
No graft queen rearing system
for mellifera bees



Queen breed tools



Material,color,size,style can be customized



Model: QB03

Grafting support

Grafting support can ascend and descend to adjust people's sitting position so as to relieve the user's injuries of cervical vertebra and lumbar vertebra; it is flexible,portable, compact , which does not occupy too much space.



Model: QB01-6

Plastic grafting tool

100% new and service to the beekeeper
Material: Plastic Black color
Total length: Approx 12 cm

2 graft tools in one box
Threading Needle: 113mm * 6mm
Packing box: 118mm * 30mm

Model: QB02-3

Desktop loupe



QB01

Aluminium handle grafting tool



QB01-2

Stainless steel grafting tool

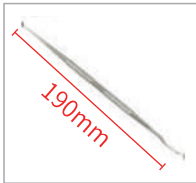

QB01-3

Stainless steel grafting tool (European style)



QB01-4

Plastic grafting tool Horn

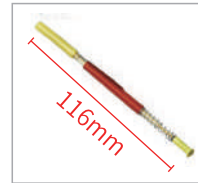

QB01-5

Plastic grafting tool Horn



QB01-7

American style plastic grafting tool



QB02

Binocular head loupe



QB02-2

Binocular head loupe



QB04-3

Queen cell cup



QB04-4

Plastic frame spacer



QB04-5

Queen cell cup (The larva not longer need to be transferred)



QB04-6

JZ BZ base mount



QB04-7

JZ BZ base mount cell cups



QB04-8

Push-In Cell Cups



QB04-10

Queen cell



QB05

Birth control tweezers



QB06-4

Mellifera adjustable bottom row



QB06-6

Mellifera impregnation queen stripe



Other products



Model: J31 (1.5L)

Honey heating pot
(Customizable 1L/2L/2.5L/3L)

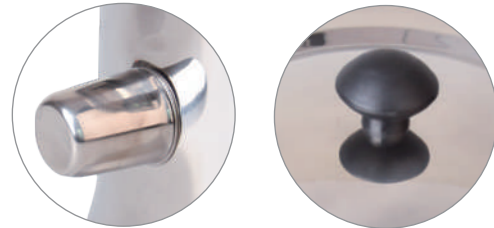

Model: QT68

Bee venom acquisition instrument



Model: J32

Honey heating pot
Material: SUS304
100X210X125mm



QT74

Thermo&humidity
meter



QT74-2

Digital thermometer



QT77

Liquid Propolis Scale
Dispenser



QT78

Liquid Propolis Scale
Dispenser

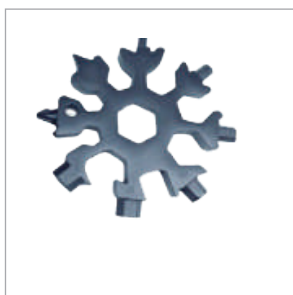

OT02

18 function combined
knife card



OT04-3

Monitor solar power



OT04

Outdoor beehive
burglar monitor



OT04-2

Outdoor beehive
burglar monitor



Other products



Model: QT60
Honey dispenser Jar



QT010
Honey dipper

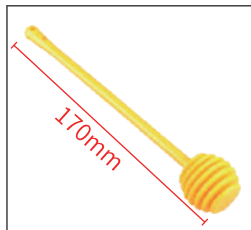

QT010-2
Honey dipper
(plastic)



QT010-3
Honey dipper
(SUS304)

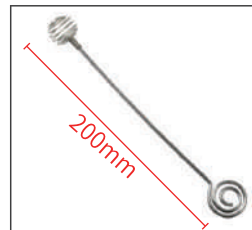

QT010-4
Honey dipper
(SUS304)



QT010-5
Honey dipper
(SUS304)

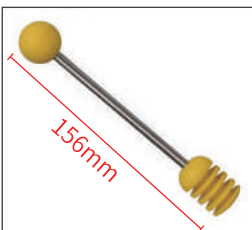

QT010-6
Honey dipper
(SUS304)



QT010-7
Dual-purpose
honey dipper



QT41-4
Digital honey
refractometer

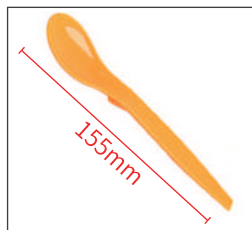

QT58
Plastic honey spoon



QT80
Honey jar linen bag



QT41
Honey refractometer
tester



QT41-3
Digital honey
refractometer (new style)



QT45
Hand labeler



OT03
Sprayer



QT81
Plastic-coated
pushpin



Pest control tools



Model:PC09-3

BB Oxalic acid heater(simple version)
 Voltage: 110V-230V
 Power: 250W
 Maximum temperature: 280°C
 CTN:10PCS

◆ Patented product

Appearance Patent No. :202030435142.7
 Utility Model Patent No. :202120820132.4

Product upgrade



PC09-2
 CTN: 10PCS



PC17-2
 CTN: 1PCS



PC18
 CTN: 20PCS



PC17
 CTN: 1PCS



PC14
 CTN:300PCS



PC15
 CTN:1000PCS



PC16
 Material: PP
 CTN:50PCS



Pest control tools



Model: PC01

Mite medicine atomizer

Handle: wooden

Material: stainless steel & aluminum

Voltage: 12V

Temperature : 160°-190°

CTN: 30PCS

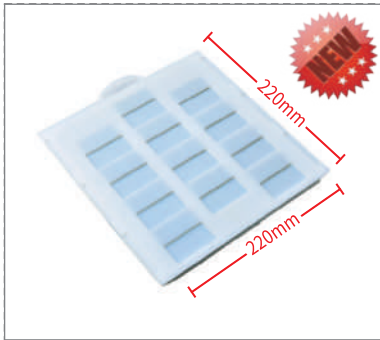

PC02
Material: pp+Plastic
CTN: 60PCS



PC04
Weight: 3.9KG
CTN: 1PCS

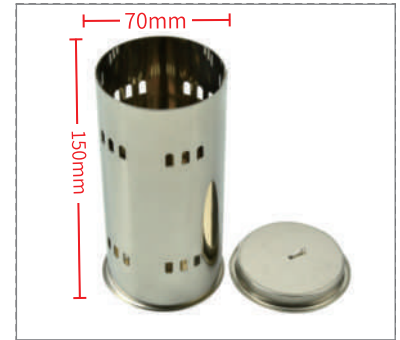

PC05
Material: SUS304
CTN: 60PCS



PC06
Material: PP
CTN: 800PCS

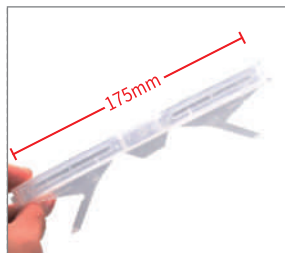

PC07
Material: PP
CTN: 1400PCS

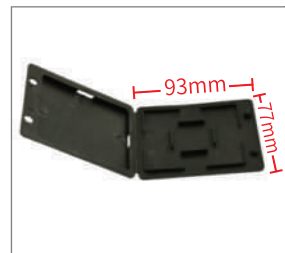

PC08
Material: PP
CTN: 500PCS



PC09
Voltage: 12V
CTN: 50PCS



PC10
Material: PP+foam
CTN: 250PCS



PC11
Material: PP
CTN: 100PCS

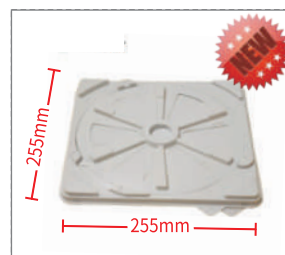

PC12
Material: PP
CTN: 80PCS



PC13
CTN: 25PCS



Bee medicines



BM22
Varroa mite-killer



BM22-1
Varroa mite-killer



BM22-2
Varroa mite-killer



BM22-3
Bee mite killer (Flumethrin strip)



BM22-4
Bee mite killer



BM25-1
Golden mite-killer



BM25-2
Golden mite-killer



BM26
Prosperous mite-killer



BM41
Amitraz aerosol (Zhenxing)



BM42
Formic acid aerosol (Zhenxing)



BM43
Varroa mite-killer (10/20pcs)



BM55
Bee bait (60ml)



Bee medicines



BM45
Fluvalinate Strips
10 /20strips



BM46
Fluvalinate Strips
10/20 strips/bag



BM47
MANPULIKE
10/20 strips/bag



BM48
Manjing - Flumethrin Strips
10/20 strips/bag



BM49
Mavrilk - Fluvalinate Strips
20 /40*2 strips/bag



BM51
Man Jie - Formic Acid Aerosol



BM52
Miticide - Amitraz
Solution Aerosol



BM53
Bee liquid (100ml)



BM54
Bee trap lure (30ml)



Bee wax



Model: BW01

Beeswax grade D ●

Pure beeswax content: 30%



Model: BW02

Beeswax grade C ●

Pure beeswax content: 50%



Model: BW03

Beeswax grade B ●

Pure beeswax content: 80%



Model: BW04

Beeswax grade A ●

Pure beeswax content: 100%

Hydrocarbon	16%-18%
Melting point	62-87 °
Acid value	16%-23%
Saponification value	75%-110%
Impurity	<0.1%
Packing	20kg/bag

Model: BW05 Pure beeswax



Model: HF04

Canola pollen
Sunflower pollen
Buckwheat pollen



HF02
Canola pollen



HF05
Sunflower pollen



Honey tank

Benefitbee®

Customizable specifications

Model:HD70/HD90

Decrystallization honey tank

HD70 70L 52X52X77CM

HD90 90L 52X52X83CM



Model : HAP06

Honey melting blanket

Size:140*44cm

Electric:220V

Average power:160W

NW:1.5KG

GW:2KG

one pc/box



Honey tank



Customizable specifications



Model:HB025-A

Material:SUS201,Honey volume: 20L,
Bucket body thickness:0.8MM,Diameter:30cm,Height:30cm
Processing technology:Seamless welding &polishing,
(Not including honey gate)

HB25-A	25KG-30X30CM
HB50-A	50KG-35X40CM
HB75-A	75KG-40X45CM
HB100-A	100KG-45X50CM
HB150-A	150KG-50X58CM
HB200-A	200KG-60X55CM



Model:HB025-B

Material:SUS201,Honey volume:20L,
Bucket body thickness:0.8MM
Diameter:30cm,Height:30cm
Processing technology:Seamless welding &polishing,
(Not including honey gate)

HB 25-B	25KG-30X30CM
HB 50-B	50KG-35X40CM
HB 75-B	75KG-40X45CM
HB100-B	100KG-45X50CM
HB150-B	150KG-50X58CM



Model: TW70-A

Thermo regulatd decrystallization
honey tank (201 steel flat lid)



Model:HC30/50/70/80/120-201

Honey tank with double-layer filter

HC30-201	30L-37X35CM
HC50-201	50L-37X47CM
HC70-201	70L-37X65CM
HC80-201	80L-37X74CM
HC120-201	120L-47X74CM(No filter)



Honey tank



Customizable specifications



Model: HB25-C

Material:SUS201,Honey volume:20L,
Bucket body thickness:0.8MM
Diameter:30cm,Height:30cm
Processing technology:Seamless welding &polishing,
(Not including honey gate)

- HB25-C 25KG 30X30CM
- HB50-C 50KG 35X40CM
- HB75-C 75KG 40X45CM
- HB100-C 100KG 45X50CM
- HB150-C 150KG 50X58CM
- HB200-C 200KG 60X55CM



Model: TW70-B

Thermo regulated decrystallization
honey tank(304 stainless steel honey gate)
Material:SUS201
Honey volume: 70L



Model: HAP05

Honey tank stand
Diameter 32cm
Height 35cm
Material: 201 T=2.0mm single side wire drawing



Honey pail

Customizable specifications



HA3/4/5/6/15/18/20L-A

3/4/5/6/15/18/20 liters plastic honey pail (zipper lid)



HA6/20/25L-B

6/20/25 liters plastic honey pail (thickened body)



HA3/6/18/20L-C

3/6/18/20 liters plastic honey pail (America style)



HAP04-30/35/40/45/50/52

Stainless steel bracket for honey barrel (H50cm, Φ30/35/40/45/50/52cm)



HPA02-2

Honey tank support

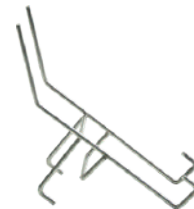

HAP02

Honey tank support



HAP07

Honey Mixer



HAP07-2

Honey Mixer



HAP07-3

Honey Mixer



HAP08

Honey straining heater



HAP01

Pail opener



HAP02-3

Honey Pail Support

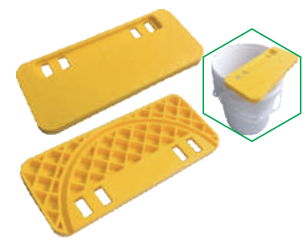

HAP03

Plastic frame scraper



Honey gates



OEM/ODM available >>

 ABS OD45mm NEW	 Nylon OD44.5mm NEW	 ABS OD48mm NEW	 SS304 OD48mm NEW
HG04	HG08	HG09	HG11
 ABS OD45mm	 ABS OD45mm	 ABS OD45mm	 ABS OD48mm NEW
HG01W	HG01G	HG01R	HG10
 ABS OD45mm	 ABS OD45mm	 Nylon OD45mm	 Nylon OD48mm
HG01Y	HG01O	HG02	HG03
 SS304 OD45mm	 SS304 OD45mm	 PP OD45mm	 SS304
HG07	HG06	HG05	HG12



Wax press



OEM/ODM available >>

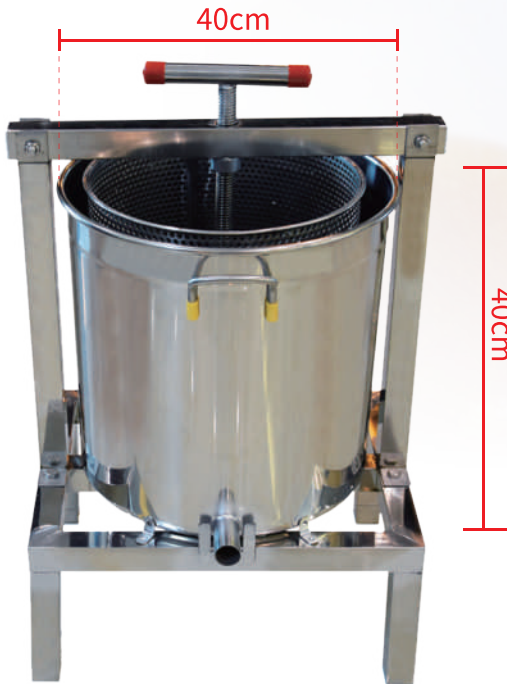

Model: ZT05

Stainless steel wax press



ZT04 (Stainless steel)



ZT03 (Iron)



ZS03 (Stainless steel)



ZT01-B (Iron)



ZS01 (Stainless steel)



ZT01 (Iron)



ZS02 (Stainless steel)



ZT02 (Iron)



ZT01-2 (Iron)



ZT01-B2 (Iron)



ZT02-2 (Iron)



ZS01-2 (Stainless steel)



ZS02-2 (Stainless steel)



Beeswax foundation roller



OEM/ODM available >>

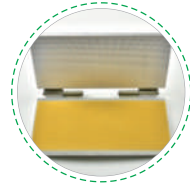

Model: FM01

Fully automatic beeswax machine

Model: FM04

Beeswax embossing machine
The size of the machine or cell
Size can be customized.

Model: FM06

Comb silicone mold



FM02-1 86X195mm



FM02-1D 86X195mm



FM02-2 86X250mm



FM02-2D 86X250mm



FM02-3 86X310mm



FM02-3D 86X310mm



FM02-4D 86X450mm



FM03-1 86X310mm



FM03-2 86X350mm

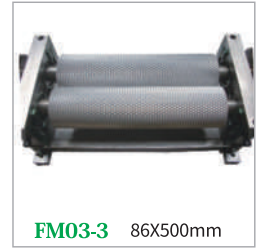

FM03-3 86X500mm



FM03-4 170X350mm



FM03-5 170X500mm



FM03-6 86X450mm



FM05-1 75X310mm



FM05-1D 75X310mm



FM05-2 75X350mm



FM05-2D 75X350mm



FM05-3 75X500mm



FM05-3D 75X500mm

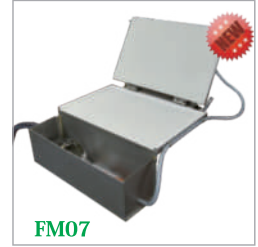

FM07

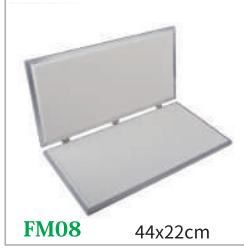

FM08 44x22cm



FM09



FM09-2

● Cell size or roller size can be customized



Model: ME01

Insemination equipment



Model: ME01-3

Insemination equipment microscope



Beekeeping tools Benefitbee efficient coupling equipment professional microscope
Instrument queen bee artificial Insemination kits



ME01-2

Insemination equipment
(Anesthesia bottle)



MEP04

Insemination equipment



MEP05

Insemination equipment
microscope



ME39

Honey filling machine



ME16

Pollen dryer



ME22

Honey and wax
separating machine



ME26

Frame support with
filter tank



Model:ME39-3

Honey filling machine

Rated voltage: DC12V AC110V AC220V
 Rated powder: 120W
 Item size:567mm * 322mm * 282mm
 Applicable capacity: 100g-5000g
 Flow rate: 500g 470 bottle/H
 Filling error: 1g
 Filling height: 0-380mm
 Applicable viscosity: Below 44 Baume degree
 Filling environment temperature: Above 5°C
 Applicable liquid temperature: 5-90°C
 Filter density: 150um
 Filtration flow: 500L/H



ME39-2
Honey filling machine



ME39-6
Honey filter



ME39-7
Honey filling machine
(copper pump)



ME39-8
Honey filling machine
(304 stainless steel pump)



ME20
Automatic spleen-cutter



ME24
Hand push type honey
pumping & shaking



ME40
Handheld branding
machine



ME27
Solar melting beewax machine



ME38
Semi-automatic cutting
machine



ME41
Pollen dryer



ME03
0.5 ton original flavor
reflux concentrator



ME03-B
1 ton original flavor
reflux concentrator



ME44
Beehive Frame
Making Machine



Candle silicone molds



Model : RS1-1006

Candle silicone mold

Mould Size: 5.5cmX8cm
Mould Weight: 130g
Product Size: 4.5X7.5cm
Product Weight: 88g



RS1-1020

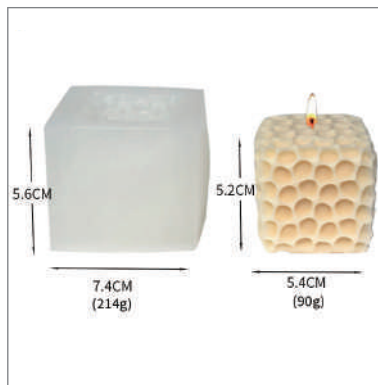

RS1-1034

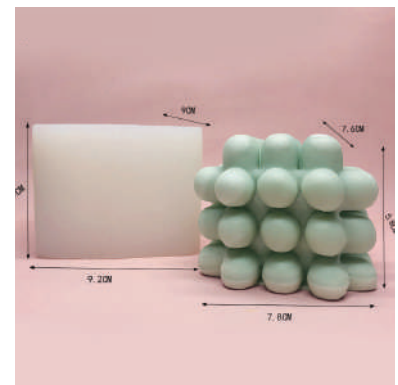

RS1-1035

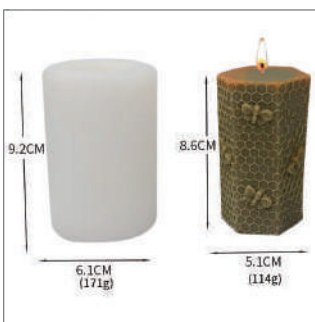

RS1-1036

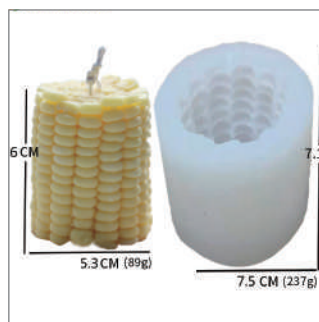

RS1-1070

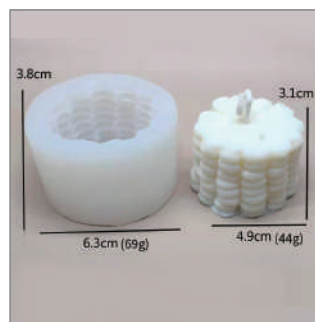

RS1-1071

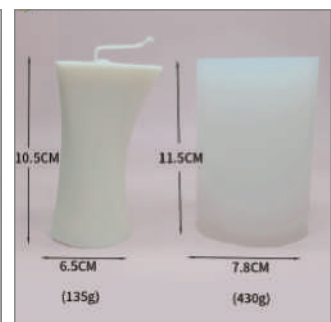

RS1-1157



RS1-1158

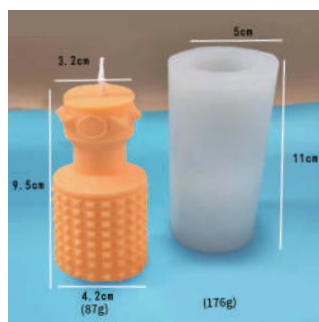

RS1-1161

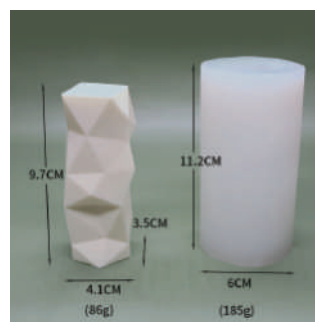

RS1-1162

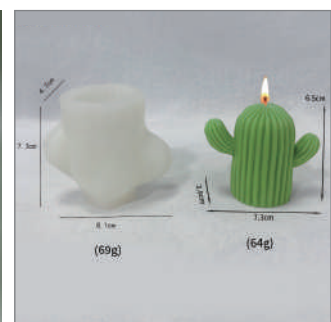

RS1-1164



Candle silicone molds

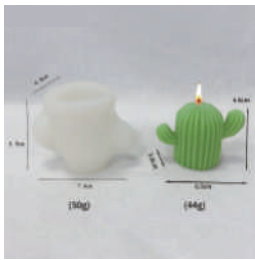

RS1-1165

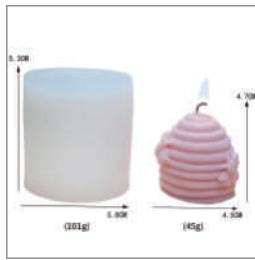

RS1-1167

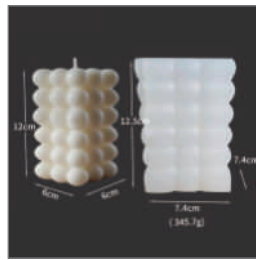

RS1-1169

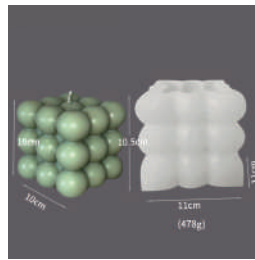

RS1-1171



RS1-1249

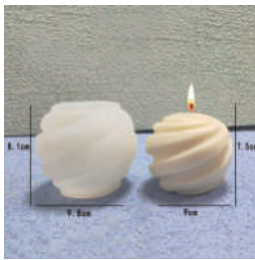

RS1-1282

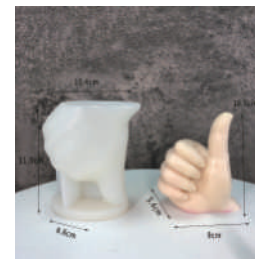

RS1-1702

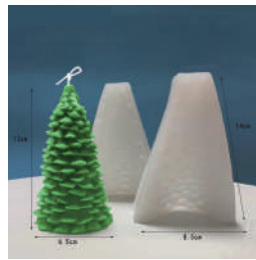

RS1-458

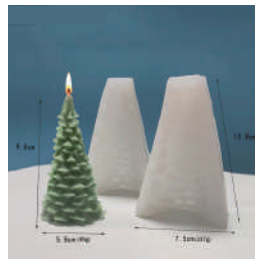

RS1-459

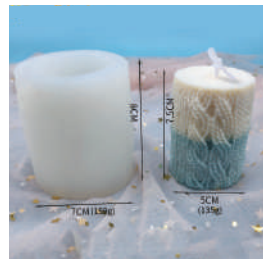

RS1-891

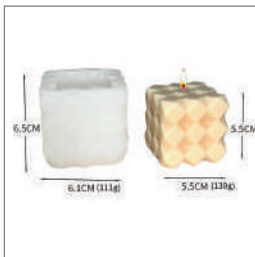

RS1-930



RS1-973

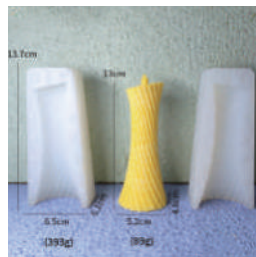

RS1-989

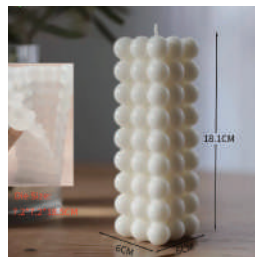

RS1-994



SR1-1513



SR1-1514



SR1-1701

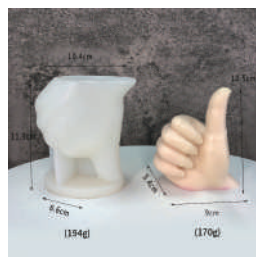

SR1-1702

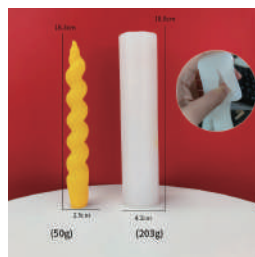

SR1-1720

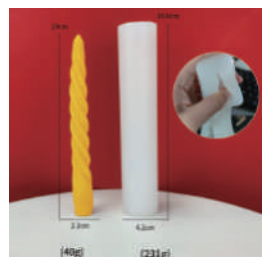

SR1-1721

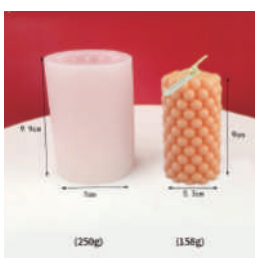

SR1-1770

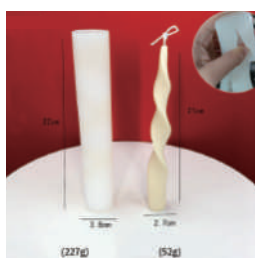

SR1-2007

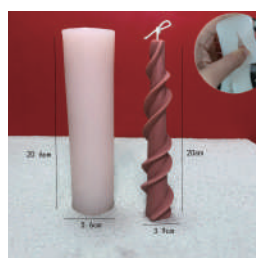

SR1-2011

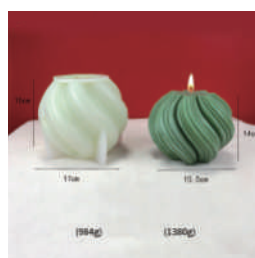

SR1-2039



SR1-2040



Candle silicone molds

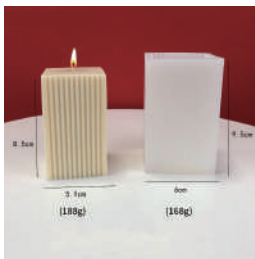

SR1-2043



SR1-2044



SR1-2045

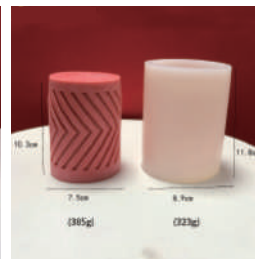

SR1-2046



SR1-2197



SR1-2262



SR1-2272

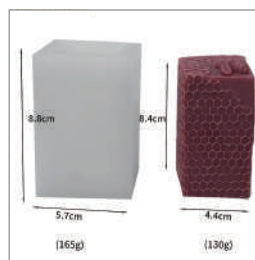

SR1-2273

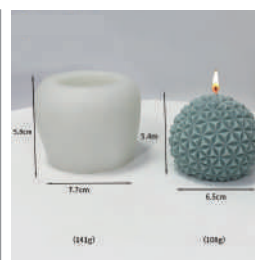

SR1-2274

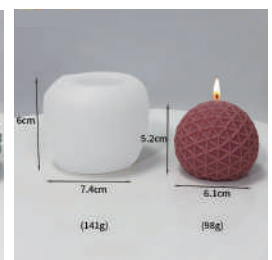

SR1-2275

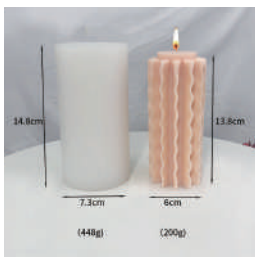

SR1-2295

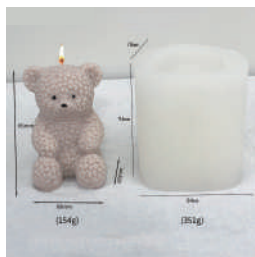

SR1-2459

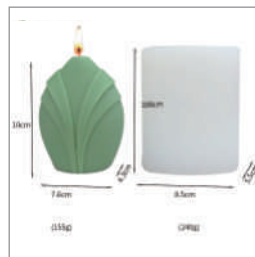

SR1-2501



SR1-2502



SR1-2503



SR1-2504



SR1-2529



SR1-2540



SR1-2639



SR1-2640



SR1-2641

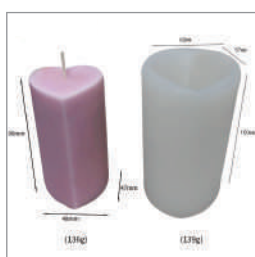

SR1-2642

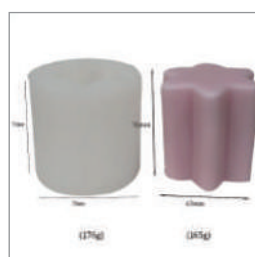

SR1-2643



Beeswax silicone moulds



SIL001
Flower heart-shaped
silicone mold



SIL002
Face cylindrical
silicone mold



SIL003
Flowery cylindrical
silicone mold



SIL004
Hexagonal silicone mold



SIL005
Owl oval silicone mold



SIL006
Butterfly square
silicone mold



SIL007
Cylindrical silicone mould



SIL008
Flower cylindrical
silicone mold



SIL009
Mermaid square
silicone mold



SIL010
Flower fairy square
silicone mold



SIL011
Honey bee hexagonal
honeycomb silicone mold



SIL012
Three flower heart-shaped
silicone mold



beeswax candle



Beeswax content: 40%

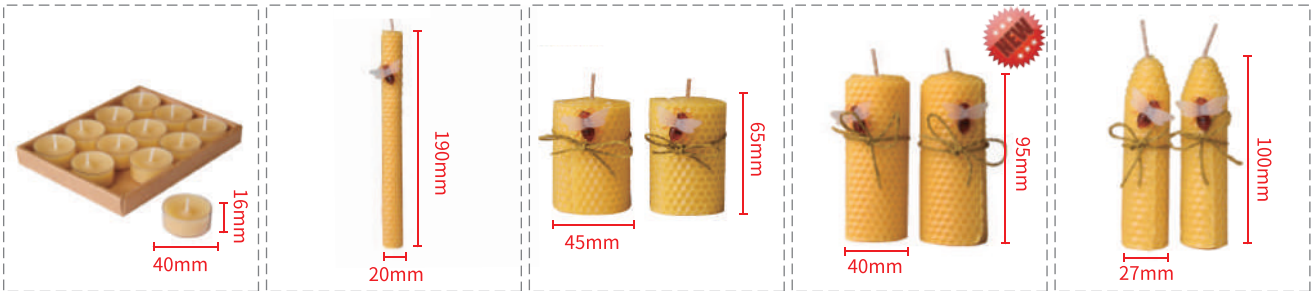

BC001
Weight: 220g

BC002
Weight: 64g

BC003
Weight: 115g

BC004
Weight: 118g

BC005
Weight: 64g

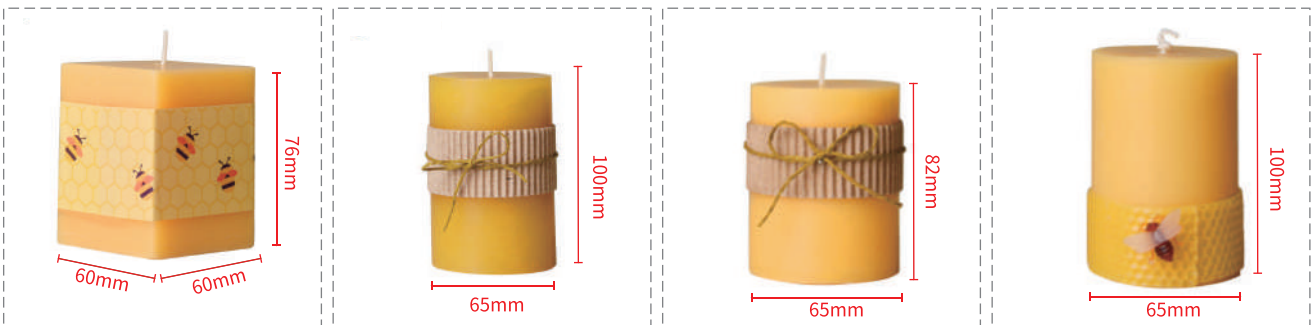

BC006
Weight: 250g

BC007
Weight: 315g

BC008
Weight: 268g

BC009
Weight: 321g

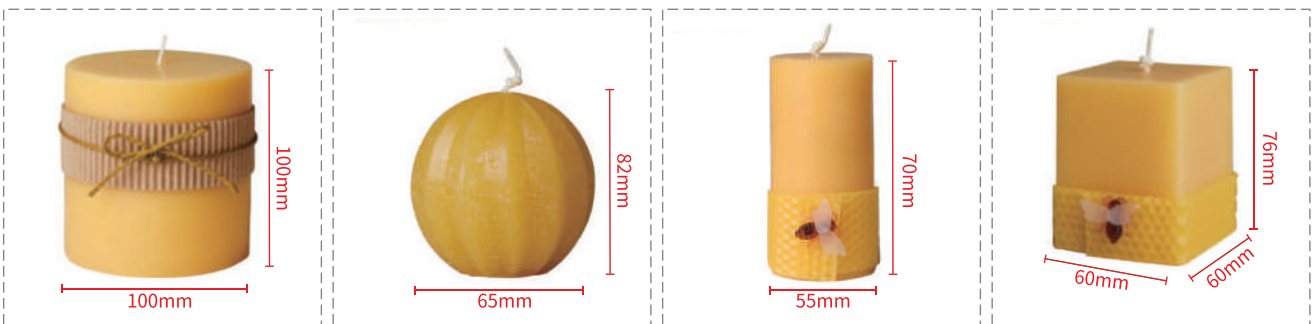

BC010
Weight: 725g

BC011
Weight: 122g

BC012
Weight: 118g

BC013
Weight: 252g

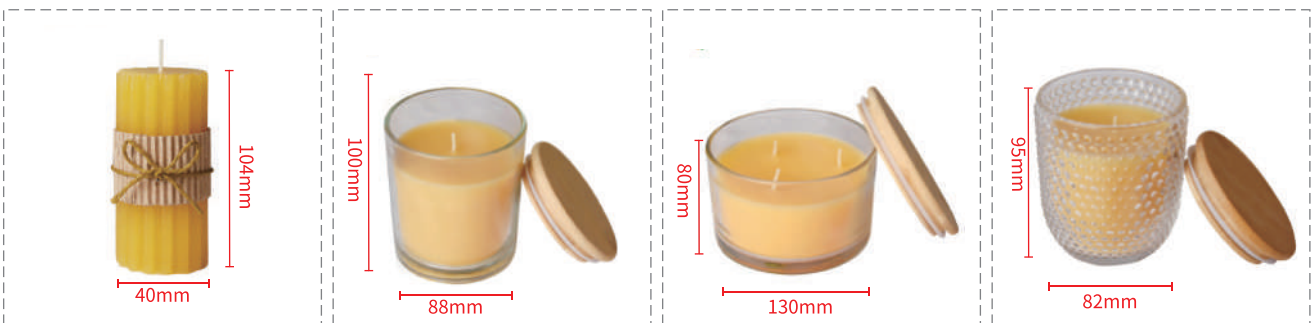

BC014
Weight: 158g

BC015
Weight: 625g

BC016
Weight: 984g

BC017
Weight: 525g



Resin crafts



Model : RC005

BB Resin craftwork

Material: Resin product
Size: 5*11cm (width * height)
Product weight; 108g

◆ **Patented product**

Patent No.:202030688284.4



RC001-1



RC001-2



RC001-3



RC001-4



RC001-5



RC001-6

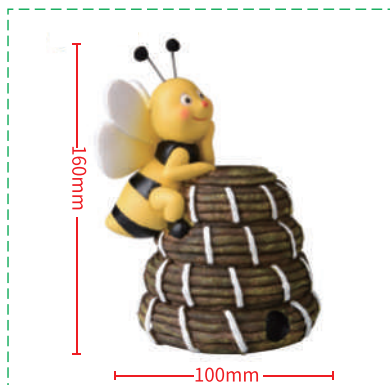

RC002



RC003



RC004



Honey bottle



Honey glass jar

Model	G09-1	G09-2	G09-3
Diameter	52mm	65mm	75mm
Height	85mm	100mm	120mm
Side	62mm	80mm	100mm
Capacity:	180ml	380ml	730ml



honey glass bottle

Model	G13	G14
Caliber:	69.5mm	80mm
Height:	104mm	137mm
Weight:	200g	350g
Capacity:	380ml	770ml

Boston Round Dropper bottle with plastic cap

Model	G12-2	
Capacity:	10ml	10ml
	15ml	20ml
	30ml	50ml
	100ml	





BNC-001
Fortune bee



BNC-002
LED smoker keychain
44th apimondia
Apiculture bronze medal for artistic exhibition



BNC-003
Bee keychain



BNC-004
Resign bee couple
with storage bucket



BNC-006



BNC-007
Motobike bee with clock
Gold medal on 44th apimondia



BNC-009
Bees lifting up honey



BNC-011
Sweetbee



BNC-012
Whole set Bottle holder



BNC-013
Bee money container



BNC-014
Umbrella with ears and a whistle



BNC-015
Umbrella of bee and flower



BNC-016
Bee pen holder



BNC-017
Bee pen holder



BNC-018
Trash can



BNC-019
Trash can



BNC-020
Guard bee



BNC-021
Lawn music Box



BNC-023
SD/USB music player



BNC-024
Lovely bee



BNC-025
Lovely bee



BNC-026
Lovely bee

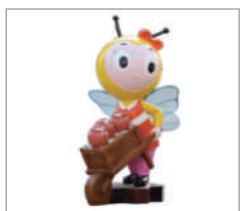

BNC-027
Lovely bee



Bee crafts



BNC-027
Rubber bee with
pot Keychain



BNC-029
Simulation model bee



BNC-038
Resin model simulation bee



BNC-040
11 designs bee models



BNC-042
Bee singer Loudspeaker



BNC-045
Bee helicopter toy



BNC-047
Cartoon bee costumes



BNC-049
Solar Swing bee In the
sunlight, leaves can swing



BNC-051
Cartoon bee mascot



BNC-052
Bee mascot keychain



BNC-053
Electric simulation
bee model



BNC-056
Bee mascot inflatable gas
model-Fengxiaobao



BNC-057
Outdoor Large inflatable
gas model -Fengxiaoya



BNC-058
Bee mascot model



BNC-059
Outdoor adversting
inflatable bee gas model



BNC-060
Barrel heater

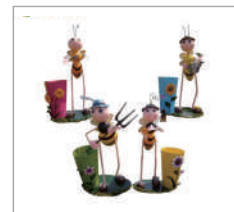

BNC-066
Iron bee gardener



BNC-068
Bee shape thermometer



BNC-073
Bee anatomical model



BNC-076
Bee development model



BNC-077
Sweet Honeybee Carrier



BNC-085
little bee backpack



BNC-086
little bee notebook



BNC-088
Children Ride On
Motorcycle



Bee broochs



AG009



AG015



AG041



AG050



AG062



AG080



AG091



AG130



AG132

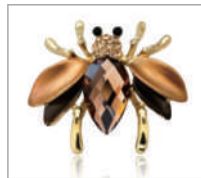

AG134



AG149



AG152



AG158



AG177



AG178



AG182



AG192



AG200



AG202

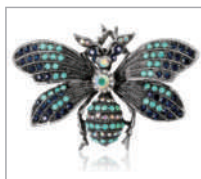

AG215



AG216



AL084

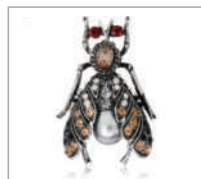

AL214



AL219



AL242



AL267



AL297

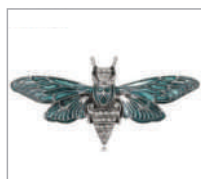

AL320



AL356

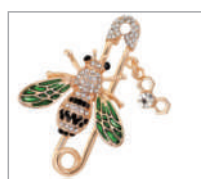

AL358



Bee accessories

Benefitbee®



BS009



BSC002



BSC067



SCB043



SCB061



SCB104



SCC046



SCC410



SCC500



SCC654



SCC654



SCC821



SCC831



SCC870



SCC879



SCC1073



SCC1102



SCC1125



SCE149



SCE315



SCE344



SCE370



SCE484



SCN191



SCN202



SCN216



SCN221



SCN242

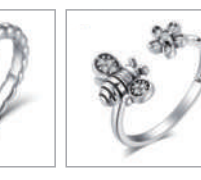

SCR025

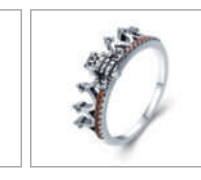

SCR086

SCR292

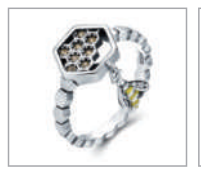

SCR329



SCR334



SCR348

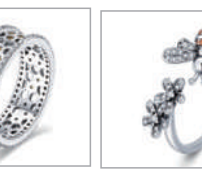

SCR391



SCR422

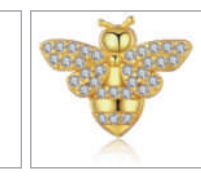

SCR433

SCX103



Bee 3D pictures

Benefitbee®



BP01



BP02



BP03



BP04



BP05



BP06



BP07



BP08



BP09



BP10

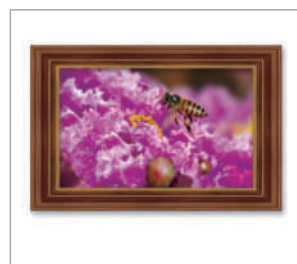

BP11



BP12



BP13



Our office





Our factory





Our factory

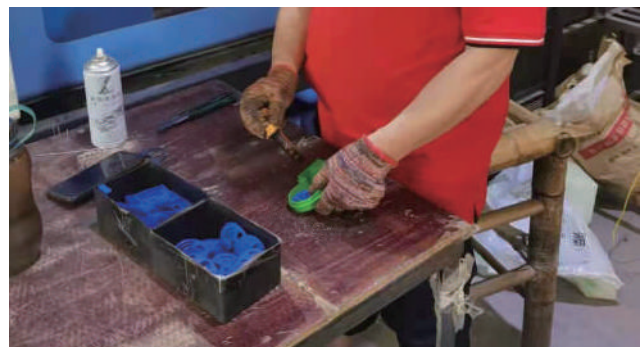



Our Beehive Plant



YOU DESERVE THE BEST FROM BENEFITBEE



 **Benefitbee**[®]



www.benefitbee.com



+86 755 89697771



info@benefitbee.com



+86 755 89697772

 ROOM 07A 26 FLOOR NEW TREND CENTRE NO.704 PRINCE EDWARD ROAD EAST SAN PO
KONG KOWLOON HK SAN PO KONG KLN,